

Installation and operation manual

Condensate drain

BEKOMAT® 8

BEKOMAT® 9

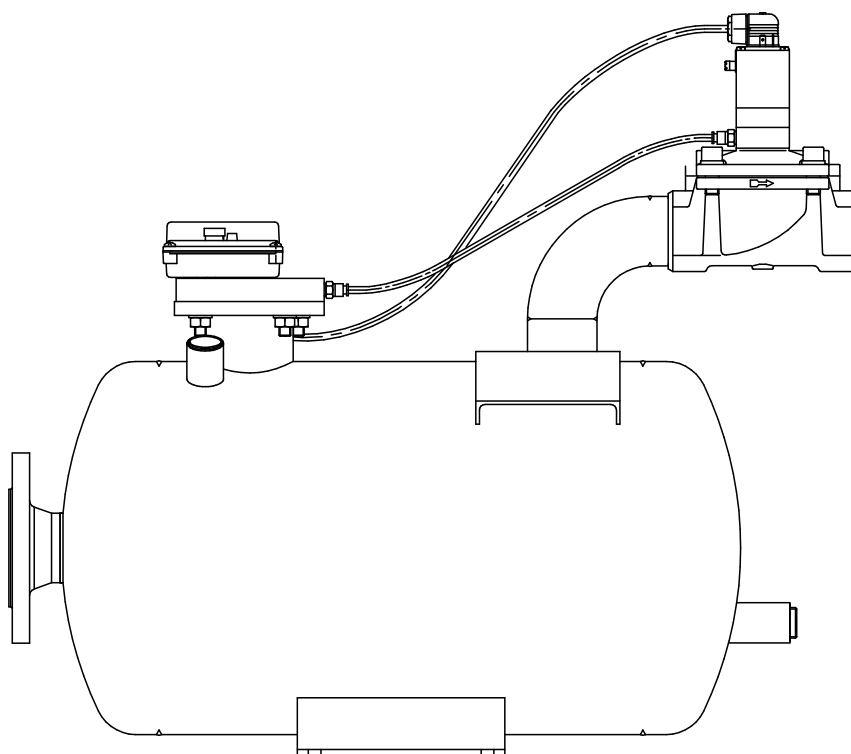

Contents

1. Safety-related information	4
1.1. Pictograms and safety symbols	4
1.1.1. In this documentation.....	4
1.1.2. On the device.....	4
1.2. Signal words	4
1.3. General safety instructions	5
1.4. Transport and storage	7
1.5. Intended use	8
1.6. Legal warranty and liability for property defects	8
2. Product information	9
2.1. Type plate on the container	9
2.2. Type plate on the electronics housing	9
2.3. Product overview and description	10
2.4. Function	11
2.4.1. Alarm mode.....	11
2.5. Dimensions	12
2.5.1. BEKOMAT® 8.....	12
2.5.2. BEKOMAT® 9.....	12
2.6. Technical data	13
2.6.1. Performance data.....	13
3. Assembly	14
3.1. Warning notices	14
3.2. Installation steps	15
4. Electrical installation	16
4.1. Installation instructions	16
4.2. Power supply	16
5. Operation	18
5.1. Functional test	19
6. Maintenance and servicing	20
6.1. Maintenance schedule	20
6.2. Cleaning	21
6.3. Spare parts	22
6.4. Accessories	22
7. Troubleshooting	23
8. Declaration of Conformity	24

1. Safety-related information

1.1. Pictograms and safety symbols

1.1.1. In this documentation



General note



Note the installation and operating manual



General hazard symbol (danger, warning, caution)



General hazard symbol (danger, warning, caution) for mains voltage and system components carrying mains voltage

1.1.2. On the device



Note the installation and operating manual (on the type plate)

1.2. Signal words

DANGER

Imminent hazard

Consequences of non-compliance: serious personal injury or even death

WARNING

Potential hazard

Consequences of non-compliance: possibly serious personal injury or even death

CAUTION

Imminent hazard





Consequences of non-compliance: possible personal injuries or damage to property

NOTE

Additional notes

Consequences of non-compliance: Disturbances during operation and maintenance.
No hazard to persons.

1.3. General safety instructions

DANGER	Insufficient qualification
	<p>Inappropriate handling due to insufficient qualification can lead to serious property damage and personal injuries or death.</p> <ul style="list-style-type: none"> • All the tasks described in this installation and operation manual may only be carried out by skilled technical personnel¹ with the qualifications described below. • The skilled technical personnel¹ must have read and understood the contents of the installation and operation manual before carrying out any tasks.
DANGER	Escaping compressed gas
	<p>Risk of serious or even fatal injury from suddenly released compressed gas, condensate or unsecured system components.</p> <ul style="list-style-type: none"> • Before carrying out any assembly, installation or maintenance work, depressurise the system. They may only be carried out by authorised skilled technical personnel¹. • Use only pressure-resistant installation materials and suitable tools that are in proper working order. • Before pressure build-up, check all unit parts and repair them, if necessary. Open valves slowly to prevent pressure blow outs in operating state. • Always prevent people or objects from being affected by condensate or escaping compressed gas. • Prevent vibrations, oscillations and impact from being transferred to system parts. • Carry out a leakage test.
DANGER	Mains voltage
	<p>Risk of electric shock with serious or even fatal injuries if contact is made with non-insulated, live components.</p> <ul style="list-style-type: none"> • Observe all applicable regulations with respect to electrical installations (e.g. VDE 0100 / IEC 60364). • Only execute installation and maintenance work when the system has been de-energised. • Electrical work may only be carried out by authorised skilled technical personnel¹.
WARNING	Operation outside of limit values
	<p>If the specified limit values are undershot and/or exceeded, there is a risk of device malfunction, potentially resulting in injury and/or damage to property.</p> <ul style="list-style-type: none"> • The device must only be operated for the intended purpose and within the permissible limits specified on the type plate and in the technical data. • Strictly adhere to the prescribed operating times and maintenance intervals.

¹Skilled technical personnel

Skilled technical personnel are people who, due to their professional qualification and knowledge in the field of measuring, control and pneumatic technology, and their knowledge of the applicable statutory regulations, guidelines and standards are in a position to independently foresee potential dangers in relation to the use of the device and who are qualified to perform the tasks described in this manual. Special assembly conditions e.g. aggressive media require additional knowledge. It is the responsibility of the device/plant owner to ensure that the instructions in this manual are adhered to.

NOTE	Legal warranty and liability for property defects
	<p>Claims based on legal or material defect liability as well as on the flawless functionality of the device can only be guaranteed by adhering to the following points:</p> <ul style="list-style-type: none"> • Do not make any modifications to the device. • Use only original spare parts and accessory parts. • Follow the installation and operation manual exactly. • Only use the device for the intended use. <p>For more information, see “Legal warranty and liability for property defects” “1.6. Legal warranty and liability for property defects” on page 8.</p>

NOTE	Installation and operation manual
	<p>Before reading, check that this installation and operation manual matches the device type. It contains important information and notes on safe operation of the device. For this reason, the installation and operation manual must always be read by the corresponding skilled technical personnel¹ before they start any tasks.</p> <p>A copy of the manual must be kept near the installation location of the device, where it is easily accessible at all times.</p> <p>In addition to this installation and operation manual, the national and company legal and safety regulations as well as accident prevention regulations required for the respective application must also be observed. This also applies to the use of accessories and spare parts.</p>

¹Skilled technical personnel

Skilled technical personnel are people who, due to their professional qualification and knowledge in the field of measuring, control and pneumatic technology, and their knowledge of the applicable statutory regulations, guidelines and standards are in a position to independently foresee potential dangers in relation to the use of the device and who are qualified to perform the tasks described in this manual. Special assembly conditions e.g. aggressive media require additional knowledge. It is the responsibility of the device/plant owner to ensure that the instructions in this manual are adhered to.

1.4. Transport and storage

Despite our best efforts, transport damage cannot be excluded. Please therefore remove all packaging material immediately after receipt and inspect the device for any possible transport damage. If you detect such damage, immediately notify the carrier company and BEKO TECHNOLOGIES GMBH or one of its agents.

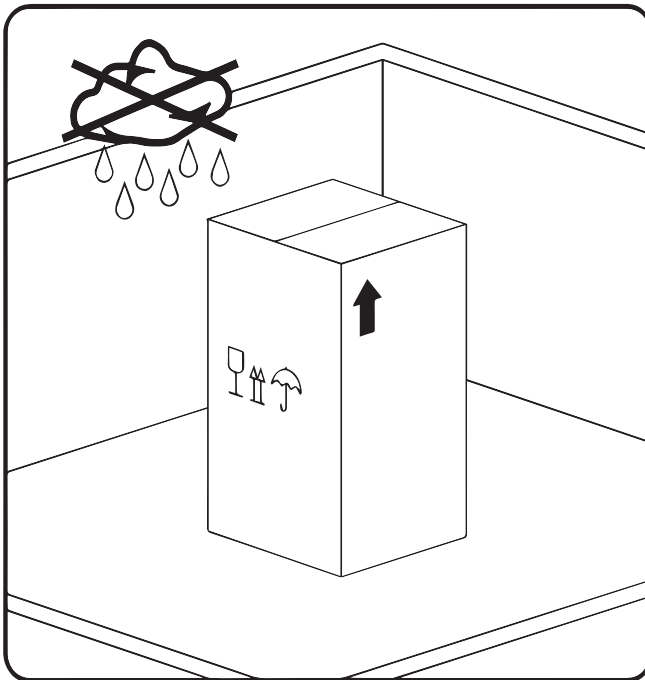

CAUTION	Damage caused during transport or storage
	<p>Inappropriate transport or storage, or the use of unsuitable lifting equipment, might cause damage to the device.</p> <ul style="list-style-type: none"> • The device may only be transported and stored by trained authorised and skilled personnel. • If you detect any damage, do not put the device into operation. • Always adhere to the permissible storage and transport temperatures. • Never expose the device to continuous, direct sunlight or heat radiation.



The device must be stored in the original packaging. Seal the packaging and store it in a dry and frost-free room. Ensure that the ambient conditions do not fall below or exceed the limits specified on the type plate.

Always take suitable measures to protect the device against the elements even in a packaged condition.

While in storage, secure the device so that it cannot topple over or fall, and protect it against vibration.

NOTE	Recycling packaging material
 	<ul style="list-style-type: none"> • The packaging material is recyclable. Dispose of the packaging material according to the applicable statutory regulations.

1.5. Intended use

The **BEKOMAT**[®] is an electronically level-controlled condensate drain for compressed air systems. This product is able to drain condensate from the system components at operating pressure with virtually no pressure loss.

- It is only suitable for use with original spare parts and accessory parts.
- The **BEKOMAT**[®] **8/9** must not be used in areas subject to frost or areas with a potentially explosive atmosphere.
- Permissible media: oil-contaminated or oil-free condensates

The **BEKOMAT**[®] may only be operated for the intended purpose and within the specifications stated in the technical data. Do not operate the unit with any substances or gas/vapour mixtures other than those listed above. Any other use of this system, which exceeds the intended use, is hereby deemed to be improper and can cause a hazard for the safety of people and the environment.

1.6. Legal warranty and liability for property defects

Warranty claims are voided if the **BEKOMAT**[®] is used for a purpose other than the intended use or operated outside the limits specified in the technical data. Such uses include (but are not limited to) the following:

- Technically incorrect installation, incorrect commissioning, incorrect maintenance or incorrect operation
- Operation with defective components
- Non-compliance with the instructions in this manual, in particular the safety instructions
- Execution of constructive interventions or modifications on the device
- Use of third-party spare parts that have not been approved by the manufacturer for repair and maintenance work

2. Product information

2.1. Type plate on the container

The type plate is attached to the device housing. It lists all the important data for the **BEKOMAT®**. Please provide the manufacturer or supplier or supplier with these on request.

W+Z Rohrsystem-Technik GmbH Weiherdamm 17 D-57250 Netphen-Deuz		Rohrsystem-Technik GmbH	
Type type	08A	Herstell-Nr serial number	64156/1
max. zul. Druck max. pressure	PS 10 bar	Baujahr year of construction	2020
min. zul. Druck min. pressure	PS 0 bar	Volumen volume	v 19,5 L
min. zul. Temperatur min. temperature	TS 1 °C	Prüfdruck test pressure	PT 14,5 bar
max. zul. Temperatur max. temperature	TS 60 °C	Prüfdatum date of inspection	01/2020
- 0045			

Beispiel / Example

2.2. Type plate on the electronics housing

The type plate is attached to the electronics housing. It lists all the important data for the **BEKOMAT®**. Please provide the manufacturer or supplier or supplier with these on request.

BM8E	0,5/10 bar 7,5-143 psig +1°/+60°C 34°/140°F	12345678 4047560	
PT: 14,5bar/210psig	110Vac±10%/50-60Hz/<25VA	IP65	Made in Germany

BEKO TECHNOLOGIES GmbH	
12345678	

Designation	Description
BM8E	Product name
PT14.5 bar / 210 psig	Test pressure
0.5/10 bar 7.5-143 psig	Max. permissible operating pressure
+1°/+60 °C 34°/140 °F	Max. permissible operating temperature
110 VAC±10 % / 50-60 Hz / < 25 VA	Operating voltage
123456789	Serial number
4047560	Product number
IP65	Degree of protection

NOTE	Handling of type plate
	Never damage, remove or make the type plate illegible.

2.3. Product overview and description

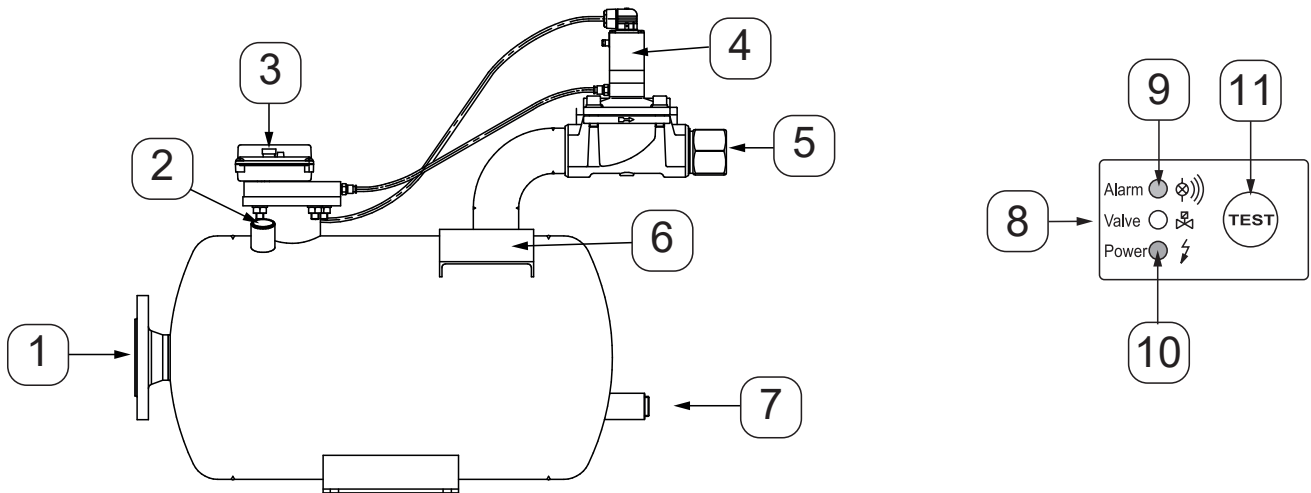

- 1 Condensate inlet
- 2 Venting line
- 3 Control elements / electric control
- 4 Solenoid valve
- 5 Condensate discharge solenoid valve
- 6 Type plate
- 7 Manual condensate drain
- 8 LED Valve
- 9 LED Alarm
- 10 LED Power
- 11 TEST button

NOTE	No permanent draining
	Do not use the TEST button for permanent draining.

2.4. Function

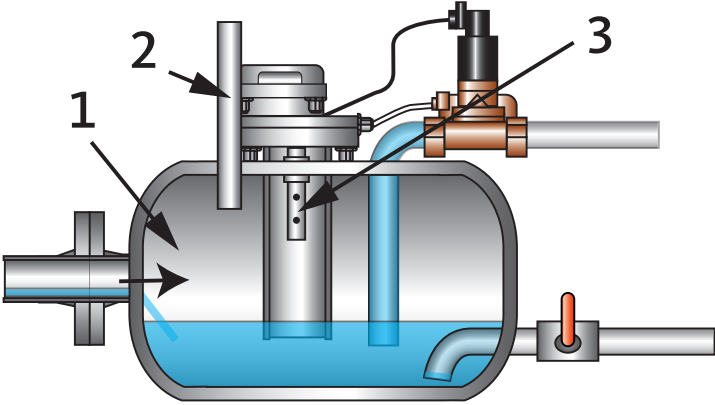
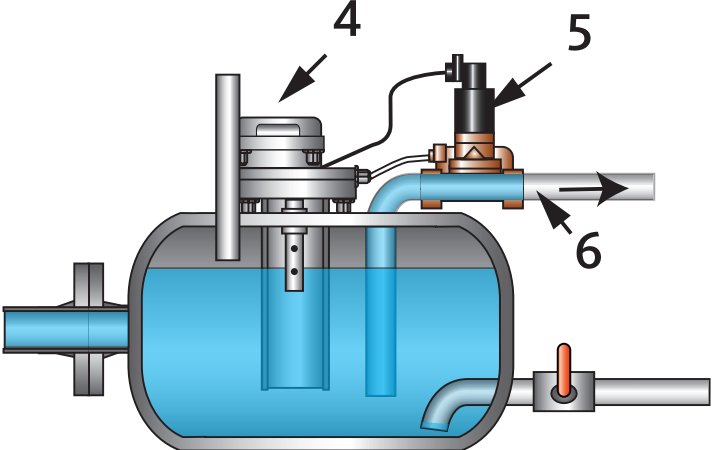
Illustration	Description / Explanation
	<p>Condensate flows through the condensate inlet and collects in the container (1). The container can fill completely, since pressure compensation takes place via the venting line (2). A capacitive double sensor (3) permanently records the filling level.</p>
	<p>As soon as the container is filled, the sensor forwards a signal to the electric control (4). This engages the solenoid valve (5), a large-area outlet membrane opens for condensate discharge (6). Under system pressure (min. 0.5 bar) the entire condensate quantity drains via the condensate discharge (6). The sensor system records the flow-off speed and controls the maximum valve opening time using this parameter. If the condensate should not flow off, the valve closes after approx. 2.5 seconds, but opens again after 2 seconds. This procedure is repeated for 1 minute. Through this valve clocking the automatic feature tries to eliminate any discharge malfunctions independently.</p>

2.4.1. Alarm mode

The BEKOMAT® is monitored by its electronics and sensors. If a malfunction is established during operation, the BEKOMAT® changes to alarm mode. This can be caused by a blocked condensate discharge or overload. In alarm mode the solenoid valve opens cyclically to eliminate the malfunction independently. If the malfunction is still present after one minute, the red LED "Alarm" flashes and the opto"coupler outlet switches. From now on, the valve opens every four minutes for 7.5 seconds until the malfunction has been eliminated independently or through maintenance. After the malfunction has been eliminated, the BEKOMAT® automatically returns to normal mode.

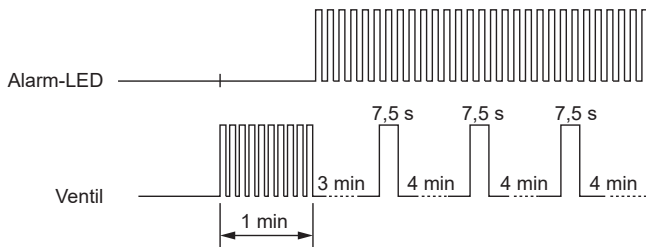

2.5. Dimensions

2.5.1. BEKOMAT® 8

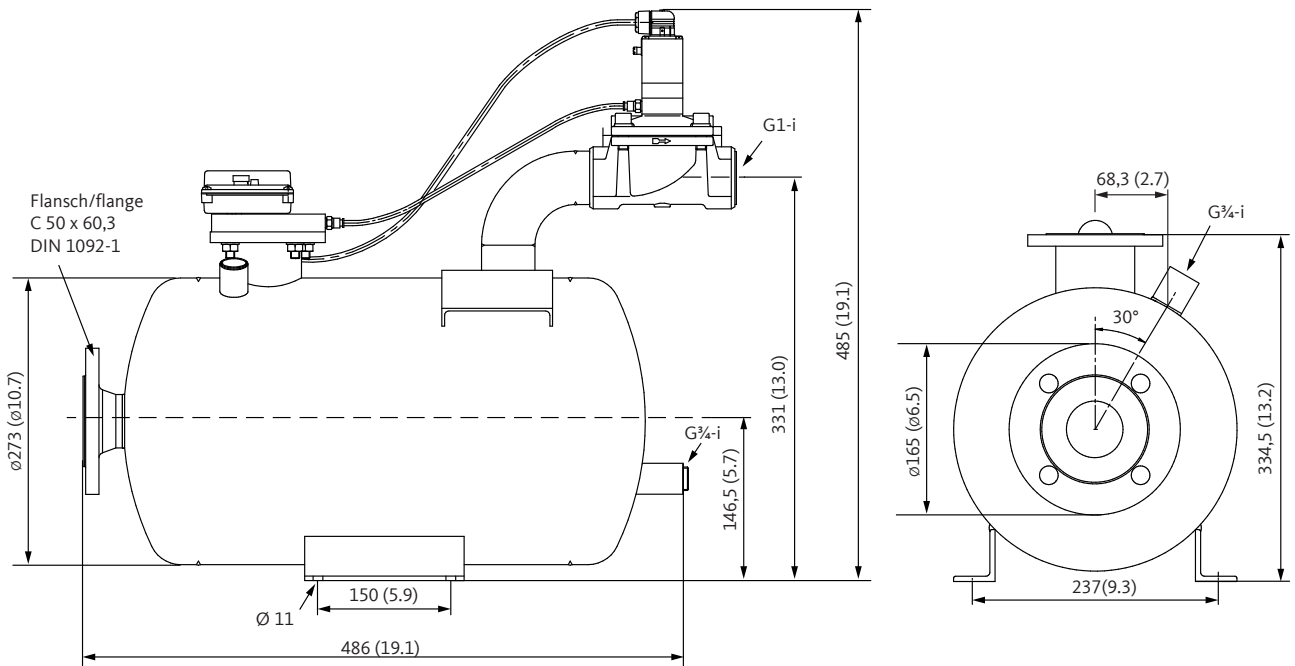

2.5.2. BEKOMAT® 9

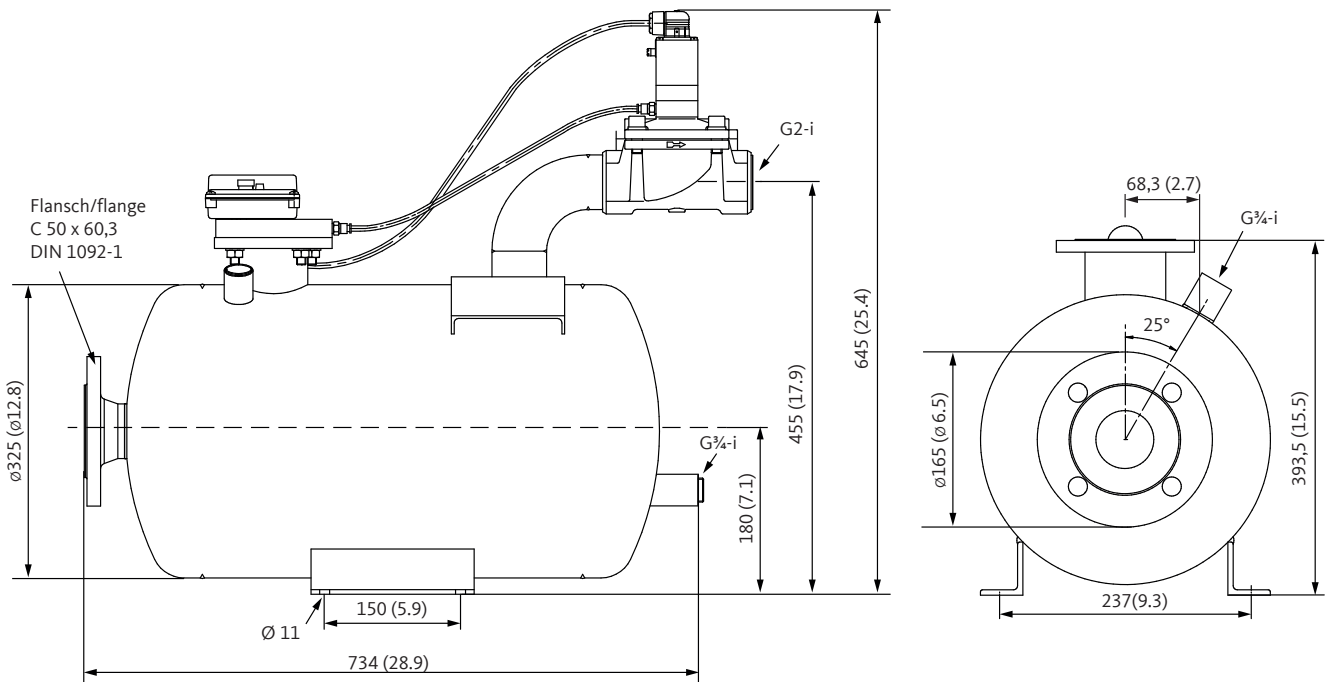

2.6. Technical data



		
General data	BM 8	BM 9
Min./max. storage/transport temperature	+1 ... +60 °C	
Min./max media/ambient temperature	+1 ... +60 °C	
Min./max operating overpressure	0.5 ... 10 bar	0.5 ... 4 bar
Condensate inlet	Fl. C50 x 60.3 DIN 1092-1	
Condensate discharge	G1	G2
Venting connection	G3/4	
Manual condensate drain	G3/4	
Condensate	Oil-contaminated, oil-free condensate	
Weight	28.0 kg (empty)	38.0 kg (empty)
Container volume	19.5 l	44 l
Drain volume per cycle	15 l	36 l
Materials	Housing: Stainless steel (material no. 1.4541) Valve: Brass	
Electrical data	BM 8	BM 9
Operating voltage	230 / 200 / 110 / 100 / 48 / 24 VAC ±10 %; 50 ... 60 Hz; 24 VDC (see type plate)	
Power consumption	< 10 VA	
Recommended cable cross section	ø 5.8 ... 11 mm; 3 x 0.75 mm ²	
Protection (medium time lag)	0.5 A	
Alarm relay: Contact load	P < 125 W / VA; I = 0.1 ... 0.5 A U < 250 VAC; U > 12 VDC	

2.6.1. Performance data

	BM 8		BM 9	
Operating pressure	Annual nominal capacity	Maximal capacity (short period)	Annual nominal capacity	Maximal capacity (short period)
[bar]	[m ³ /a]	[l/h]	[m ³ /a]	[l/h]
0.5	9,360	1,400	24,000	3,600
1.0	10,700	2,250	29,200	6,130
2.0	11,100	3,330	29,600	8,880
4.0	11,400	4,800	30,000	12,600
6.0	12,700	5,580	--	--
8.0	13,700	6,000	--	--
10.0	14,400	6,300	--	--

3. Assembly

3.1. Warning notices

DANGER	Insufficient qualification, explosion
	<p>Inappropriate handling due to insufficient qualification can lead to explosions, serious property damage and personal injuries or death.</p> <ul style="list-style-type: none"> • All the tasks described in this installation and operation manual may only be carried out by skilled technical personnel¹ with the qualifications described below. • The skilled technical personnel¹ must have read and understood the contents of the installation and operation manual before carrying out any tasks.
DANGER	Escaping compressed gas
	<p>Risk of serious or even fatal injury through faulty assembly or non-secured system components.</p> <ul style="list-style-type: none"> • Depressurise the system before carrying out any assembly work. • Use only pressure-resistant installation materials and suitable tools that are in proper working order. • Before pressure build-up, check all unit parts and repair them, if necessary. Open valves slowly to prevent pressure blow outs in operating state. • Always prevent people or objects from being affected by condensate or escaping compressed gas. • Prevent vibrations, oscillations and impact from being transferred to system parts. • Carry out a leakage test.

¹**Skilled technical personnel**

Skilled technical personnel are people who, due to their professional qualification and knowledge in the field of measuring, control and pneumatic technology, and their knowledge of the applicable statutory regulations, guidelines and standards are in a position to independently foresee potential dangers in relation to the use of the device and who are qualified to perform the tasks described in this manual. Special assembly conditions e.g. aggressive media require additional knowledge. It is the responsibility of the device/plant owner to ensure that the instructions in this manual are adhered to.

3.2. Installation steps

The following illustrations show possible assembly of the **BEKOMAT® 8/9**.

NOTE	Assembly instructions
	<ul style="list-style-type: none"> • Install a separate BEKOMAT® at each point where condensate occurs. • Do not use any tapered threaded joints. • Keep pipe length as short as possible. • Do not fit a filter/dirt trap into the condensate inlet. • Only use ball valves for the condensate inlet. • The venting line must be above the max. possible condensate level. • Observe minimum assembly heights

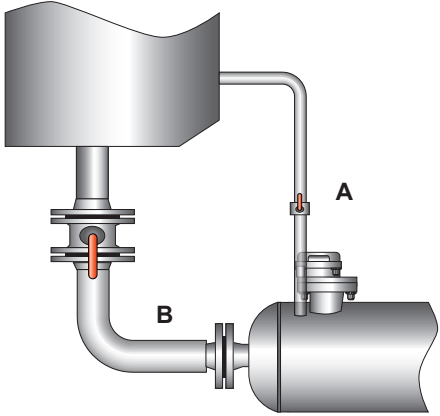
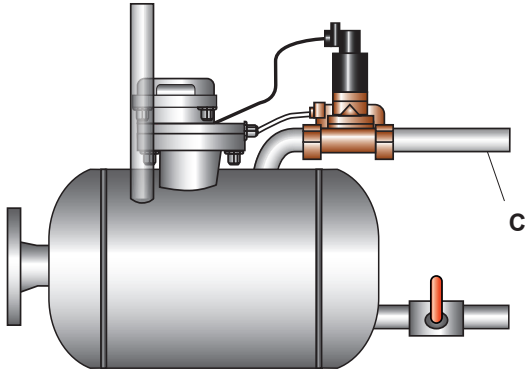
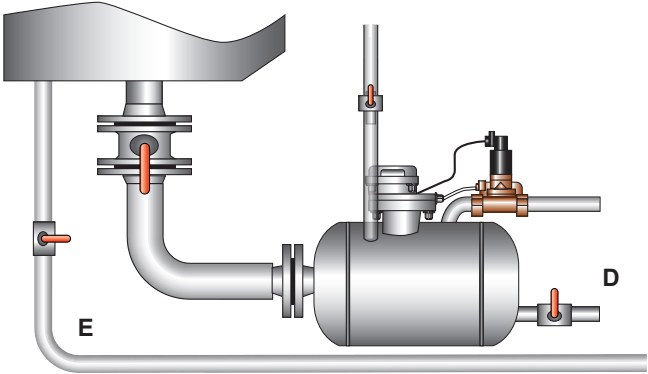
Installation BEKOMAT® 8/9	
	<p>Venting A: Install line $\geq 3/4"$ with ball valve</p> <p>Condensate inlet B: Install pipe $\geq 2"$ (DN 50) with flange and ball valve:</p> <ul style="list-style-type: none"> • Short feed line! • Slope of the condensate inlet $> 1\%$! • No filter in the condensate inlet!
	<p>Condensate discharge C: Install line $\geq 1"$ ($\geq 2"$ for BEKOMAT® 9):</p> <ul style="list-style-type: none"> • Do not route into a manifold! • Max. 5 m incline! • The minimum operating pressure increases by 0.1 bar per metre of incline!
	<p>For maintenance purposes:</p> <p>Manual condensate drain D:</p> <ul style="list-style-type: none"> • Install $\geq 3/4"$ with ball valve <p>Bypass line E:</p> <ul style="list-style-type: none"> • Install $\geq 1"$ with ball valve

4. Electrical installation

4.1. Installation instructions

DANGER	Insufficient qualification
	Inappropriate handling due to insufficient qualification can lead to serious property damage and personal injuries or death.
	<ul style="list-style-type: none"> • All the tasks described in this installation and operation manual may only be carried out by skilled technical personnel¹ with the qualifications described below. • The skilled technical personnel¹ must have read and understood the contents of the installation and operation manual before carrying out any tasks.

DANGER	Mains voltage
	Risk of electric shock with serious or even fatal injuries if contact is made with non-insulated, live components.
	<ul style="list-style-type: none"> • Observe all applicable regulations with respect to electrical installations (e.g. VDE 0100 / IEC 60364). • Only execute installation and maintenance work when the system has been de-energised. • Electrical work may only be carried out by authorised skilled technical personnel¹.

¹Skilled technical personnel

Skilled technical personnel are people who, due to their professional qualification and knowledge in the field of measuring, control and pneumatic technology, and their knowledge of the applicable statutory regulations, guidelines and standards are in a position to independently foresee potential dangers in relation to the use of the device and who are qualified to perform the tasks described in this manual. Special assembly conditions e.g. aggressive media require additional knowledge. In addition, the requirements on “skilled technical personnel” set out in the Technical Rules for Operating Safety (TRBS) must be observed. It is the responsibility of the device/plant owner to ensure that the instructions in this manual are adhered to.

4.2. Power supply

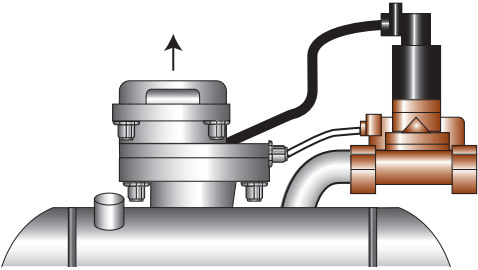
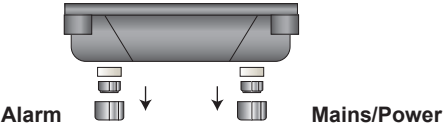
	<p>Open the top cover:</p> <ul style="list-style-type: none"> • Loosen 4 screws • Lift top cover off
	<p>For mains connection (or alarm tapping): Loosen the screwed cable gland(s) on the bottom cover</p>

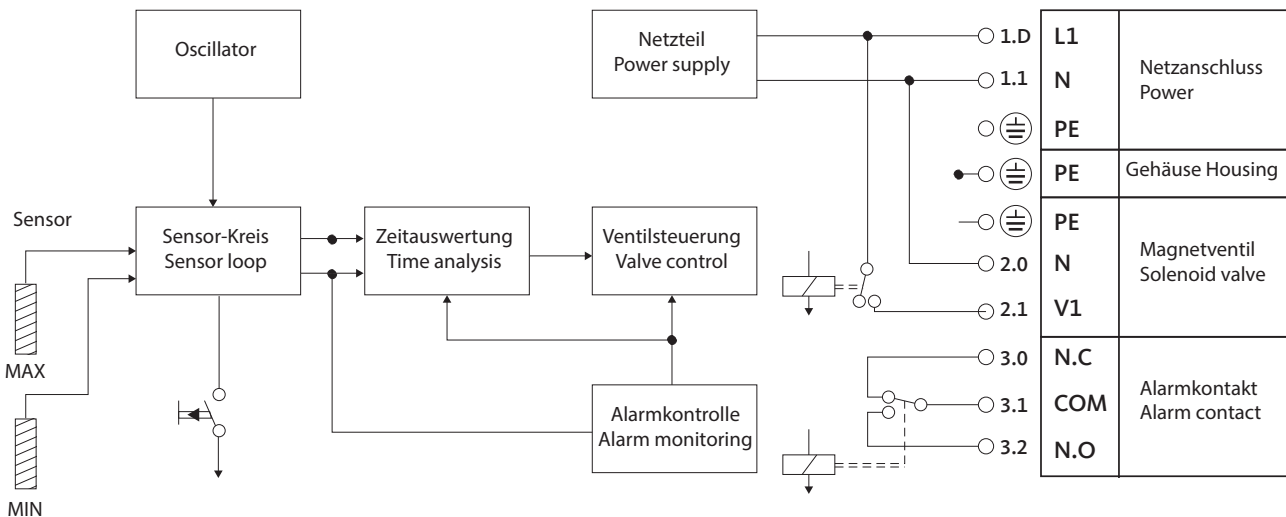
**Mains connection:**

- Route the cable through the screwed cable gland and connect to terminals **L1, N, PE**

Alarm tapping:

There is a potential-free alarm relay (changeover) available to forward the alarm in the event of a malfunction:

- Route the cable through the second screwed cable gland and connect it

N.C. – COM:

Contact closed in the event of a malfunction or power failure (fail-safe principle)

N.O. – COM:

Contact opened in the event of a malfunction or power failure

- Tighten screwed cable gland(s)
- Set the top cover in place, check correct fit and tighten the screws

5. Operation

The following displays show the different system states of the **BEKOMAT®**.

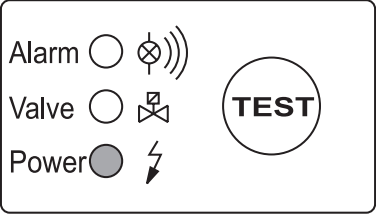
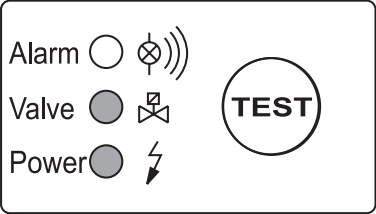
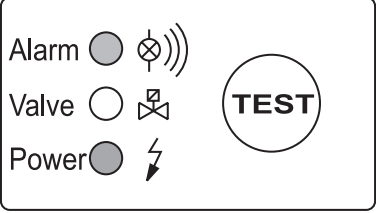
Normal state:	
 <p>Alarm ○ ⊕))) Valve ○ ⊕ Power ● ⚡</p>	<p>Normal operation:</p> <ul style="list-style-type: none"> Green LED "Power" lights up: Voltage OK, BEKOMAT® in operation
Fault state:	
 <p>Alarm ○ ⊕))) Valve ● ⊕ Power ● ⚡</p>	<ul style="list-style-type: none"> Yellow LED "Valve" lights up: Filling level reached → Valve opens, condensate is discharged <p>The valve opening time varies sensor-controlled (depending on the flow-off speed).</p> <p>After condensate discharge:</p> <ul style="list-style-type: none"> - BEKOMAT® is emptied to maximum extent - Valve closes in good time - No unnecessary pressure loss
Alarm state:	
 <p>Alarm ● ⊕))) Valve ○ ⊕ Power ● ⚡</p>	<p>ALARM malfunction case:</p> <ul style="list-style-type: none"> Pressure too low to open the valve Condensate occurrence too high → see "Performance data" Inlet or drain line clogged or blocked Excessive dirt in medium (valve clogged) Solenoid valve defective → see "Maintenance" Pipe frozen Installation not carried out properly → see "Installation" <p>The alarm is automatically cancelled when the malfunction has been eliminated.</p>

5.1. Functional test

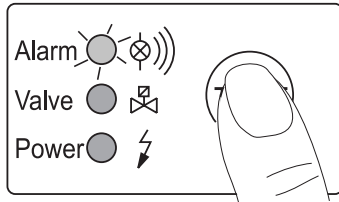

Check normal function

To check the solenoid valve, press the TEST button briefly (approx. 2 sec.).

→ Red LED "Alarm" flashes, yellow LED "Valve" lights up

→ Valve opens for condensate discharge

Test fault signal

To test the solenoid valve, shut off the condensate inlet and press the TEST button for approx. 1 minute.

→ Alarm relay switches

Release the TEST button

→ **BEKOMAT**[®] returns to normal function

- Open condensate inlet again!
- Minimum operating pressure 0.5 bar!

6. Maintenance and servicing

DANGER	Insufficient qualification
	Inappropriate handling due to insufficient qualification can lead to serious property damage and personal injuries or death.
	<ul style="list-style-type: none"> Maintenance work may only be carried out by trained service personnel from BEKO TECHNOLOGIES GmbH or authorised partners.

Recommendation: Annually

Respective set of wear parts:

BEKOMAT® 8 2000450

BEKOMAT® 9 4005382

Before all maintenance:

- Shut off the supply line
- Press the TEST button until the **BEKOMAT®** is pressureless
- Disconnect the **BEKOMAT®** from the mains voltage

6.1. Maintenance schedule

Maintenance	Interval
Functional test <ul style="list-style-type: none"> Press the TEST button Visual inspection 	daily
Maintenance <ul style="list-style-type: none"> Replace the set of wear parts Leakage test Functional test Check adhesive labels and replace if necessary Check length of valve core Check cable connections Cleaning 	annually

Functional test:

The **BEKOMAT®** should be tested daily for flawless function.

- To check the solenoid valve, press the TEST button briefly (approx. 2 sec.).
→ The **BEKOMAT®** starts manual drainage.
 - To check the fault signal, shut off the condensate inlet and press the TEST button for approx. 1 minute.
→ The **BEKOMAT®** starts manual drainage and triggers the alarm.
- i** During this test, larger quantities of compressed gas can flow into the condensate collecting line.

Maintenance:

Further information about maintenance will be provided on request.

6.2. Cleaning

The **BEKOMAT®** is cleaned with a damp (not wet) cotton or disposable cloth as well as mild, commercially available detergent / soap.

Spray a little detergent onto the clean cotton cloth or disposable cloth and carefully wipe the component. Then dry using a clean cloth or let it dry at room temperature. Observe all hygiene instructions applicable on the site.

NOTE	Damage to device caused by improper cleaning
	Cleaning with a wet cloth, hard or pointed implement or aggressive detergent can damage the components and integrated electronic components.
	<ul style="list-style-type: none"> • Never clean the device with a dripping wet cloth. • Do not use aggressive detergents. • Never clean the device with hard or pointed implements.

Cleaning

A. Clean container:

Do not press the TEST button, rather:

- Shut off the supply line
- Carefully open the manual condensate drain on the container
- Residual pressure flushes the container

B. Clean sensor tube:

- Disassemble the flange on the top side of the container (loosen hose connection, cable connector and flange screws, lift out flange with electronics and sensor tube)
- Only clean the sensor tube from the outside
- Assemble components properly

C. Clean valve:

Only loosen the screw that are not colour-marked! Coloured screws have been set in the factory and must not be adjusted!

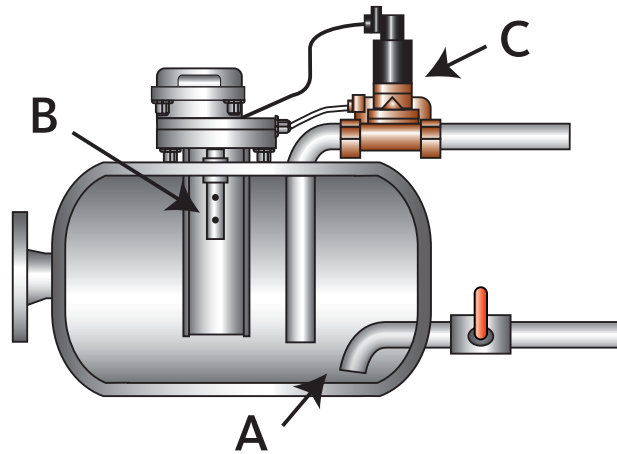

6.3. Spare parts

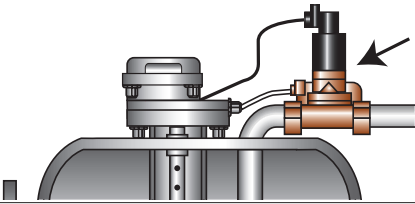
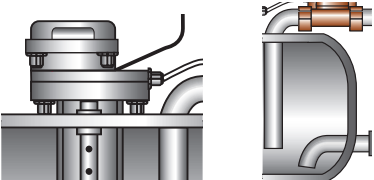
	<p>Set of wear parts</p> <p>1 x solenoid valve, complete 2 x hose connector 1 x hose section</p>	<p>BEKOMAT® 8 230 VAC 2000450</p> <p>BEKOMAT® 9 230 VAC 4005382</p> <p>Other voltages on request</p>
	<p>Set of seals</p> <p>8 x seal in sensor area 1 x seal at manual condensate drain</p>	<p>BEKOMAT® 8/9 2000683</p>
	<p>Circuit board 230 VAC 1 x circuit board 230 VAC</p>	<p>BEKOMAT® 8 2000763</p> <p>BEKOMAT® 9 4005381</p>
	<p>Circuit board 110 VAC 1 x circuit board 110 VAC</p>	<p>BEKOMAT® 8 2002768</p> <p>BEKOMAT® 9 4013115</p>
	<p>Circuit board 24 VDC 1 x circuit board 24 VDC</p>	<p>BEKOMAT® 8 2000231</p> <p>BEKOMAT® 9 2001970</p>

6.4. Accessories

The table below indicates possible accessories.

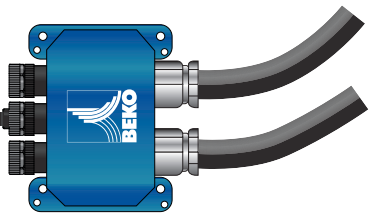
Illustration	Description	Order number*
	Trace heater	<p>BEKOMAT® 8/9 2801233</p>
	Heating tape extension 3 m	<p>BEKOMAT® 8/9 2801232</p>

7. Troubleshooting

If malfunctions cannot be eliminated, the device should be sent in to us for repair. The device must be cleaned carefully first and packed in a break-proof way. A return dispatch declaration with detailed description of the malfunction must be enclosed with the faulty device. If your device has come into contact with pollutants, a decontamination declaration is also required. You will find corresponding templates on our website at www.beko-technologies.com. If you should return your device without a decontamination declaration and our Service department has doubts about the medium used, repairs will only be started once a respective declaration has been received. If the device has come into contact with pollutants, appropriate precautionary measures must be taken during cleaning!

8. Declaration of Conformity

BEKO TECHNOLOGIES GMBH
Im Taubental 7
41468 Neuss

GERMANY

Tel: +49 2131 988-0
www.beko-technologies.com



EU-Konformitätserklärung

Wir erklären hiermit, dass die nachfolgend bezeichneten Produkte den Anforderungen der einschlägigen Richtlinien und technischen Normen entsprechen. Diese Erklärung bezieht sich nur auf die Produkte in dem Zustand, in dem sie von uns in Verkehr gebracht wurden. Nicht vom Hersteller angebrachte Teile und/oder nachträglich vorgenommene Eingriffe bleiben unberücksichtigt.

Produktbezeichnung:	Kondensatableiter
Modelle:	BEKOMAT® 8 ..., 9 ...
Spannungsvarianten:	24 VDC, 24 VAC, 100 VAC, 110 VAC, 200 VAC, 230 VAC
Max. Betriebsdruck	10 bar (g) (nur BEKOMAT® 8) 4 bar (g) (nur BEKOMAT® 9)
Produktbeschreibung und Funktion:	Kondensatableiter zur elektronisch niveaugeregelten Ableitung von Kondensat im Druckluftnetz für Fluidgruppe 2.

Druckgeräte-Richtlinie 2014/68/EU

Angewandtes Konformitätsbewertungsverfahren: Modul A: Interne Fertigungskontrolle, Kategorie I

Niederspannungs-Richtlinie 2014/35/EU

Angewandte Normen: EN 61010-1: 2010
Kapitel 1-14, 16, 17, Anhang A-D, F, G, I-L, ZA

Die Geräte mit einer Betriebsspannung von 24 VAC und 24 VDC fallen nicht in den Anwendungsbereich der Niederspannungs-Richtlinie.

EMV-Richtlinie 2014/30/EU

Angewandte Normen: EN 61326-1: 2013

ROHS II-Richtlinie 2011/65/EU

Die Vorschriften der Richtlinie 2011/65/EU zur Beschränkung der Verwendung bestimmter gefährlicher Stoffe in Elektro- und Elektronikgeräten werden erfüllt.

Der Hersteller trägt die alleinige Verantwortung für die Ausstellung dieser Konformitätserklärung.

Unterzeichnet für und im Namen von:

Neuss, 04.08.2016

BEKO TECHNOLOGIES GMBH

i.V. Christian Riedel
Leiter Qualitätsmanagement International

BEKO TECHNOLOGIES GMBH
 Im Taubental 7
 41468 Neuss

GERMANY

Phone: +49 2131 988-0
 www.beko-technologies.com



EU Declaration of Conformity

We hereby declare that the products named below comply with the stipulations of the relevant directives and technical standards. This declaration only refers to products in the condition in which they have been placed into circulation. Parts which have not been installed by the manufacturer and/or modifications which have been implemented subsequently remain unconsidered.

Product designation:	Condensate drain
Type:	BEKOMAT® 8 ..., 9 ...
Supply voltage versions:	24 VDC, 24 VAC, 100 VAC, 110 VAC, 200 VAC, 230 VAC
Max. operating pressure	10 bar (g) (only BEKOMAT® 8) 4 bar (g) (only BEKOMAT® 9)
Product description and function:	Condensate drain for the electronically level-controlled discharge of condensate in the compressed-air system fluid group 2.

Pressure Equipment Directive 2014/68/EU

Applied conformity assessment procedure: Module A: Internal production control, Category I

Low Voltage Directive 2014/35/EU

Applied standards: EN 61010-1: 2010
 Section 1-14, 16, 17 Annex A-D, F, G, I-, ZA

The devices designed for 24 VDC and 24 VAC supply power are not subject to the requirements laid down in the European Low Voltage Directive.

EMC Directive 2014/30/EU

Applied standards: EN 61326-1: 2013

RoHS II Directive 2011/65/EU

The products meet the requirements laid down in European Directive 2011/65/EU concerning the restriction of the use of certain hazardous substances in electrical and electronic devices.

The manufacturer shall have sole responsibility for issuing this declaration of conformity.

Signed for and on behalf of:

Neuss, 04.08.2016

BEKO TECHNOLOGIES GMBH

i.V. Christian Riedel
 Head of International Quality Management

BEKO TECHNOLOGIES GmbH

Im Taubental 7
D - 41468 Neuss
Tel. +49 2131 988 0
Fax +49 2131 988 900
info@beko-technologies.com
service-eu@beko-technologies.com

DE**BEKO TECHNOLOGIES LTD.**

Unit 11-12 Moons Park
Burnt Meadow Road
North Moons Moat
Redditch, Worcs, B98 9PA
Tel. +44 1527 575 778
info@beko-technologies.co.uk

GB**BEKO TECHNOLOGIES S.à.r.l.**

Zone Industrielle
1 Rue des Frères Rémy
F - 57200 Sarreguemines
Tél. +33 387 283 800
info@beko-technologies.fr
service@beko-technologies.fr

FR**BEKO TECHNOLOGIES B.V.**

Veenen 12
NL - 4703 RB Roosendaal
Tel. +31 165 320 300
benelux@beko-technologies.com
service-bnl@beko-technologies.com

NL**BEKO TECHNOLOGIES
(Shanghai) Co. Ltd.**

Rm.715 Building C, VANTONE Center
No.333 Suhong Rd.Minhang District
201106 Shanghai
Tel. +86 (21) 50815885
info.cn@beko-technologies.cn
service1@beko.cn

CN**BEKO TECHNOLOGIES s.r.o.**

Na Pankraci 58
CZ - 140 00 Praha 4
Tel. +420 24 14 14 717 /
+420 24 14 09 333
info@beko-technologies.cz

CZ**BEKO Tecnológica España S.L.**

Torruella i Urpina 37-42, nave 6
E - 08758 Cervelló
Tel. +34 93 632 76 68
Mobil +34 610 780 639
info.es@beko-technologies.es

ES**BEKO TECHNOLOGIES LIMITED**

Room 2608B, Skyline Tower,
No. 39 Wang Kwong Road
Kwloon Bay Kwloon, Hong Kong
Tel. +852 2321 0192
Raymond.Low@beko-technologies.com

HK**BEKO TECHNOLOGIES INDIA Pvt. Ltd.**

Plot No.43/1 CIEEP Gandhi Nagar
Balanagar Hyderabad
IN - 500 037
Tel. +91 40 23080275 /
+91 40 23081107
Madhusudan.Masur@bekoindia.com
service@bekoindia.com

IN**BEKO TECHNOLOGIES S.r.l**

Via Peano 86/88
I - 10040 Leinì (TO)
Tel. +39 011 4500 576
Fax +39 0114 500 578
info.it@beko-technologies.com
service.it@beko-technologies.com

IT**BEKO TECHNOLOGIES K.K**

KEIHIN THINK Building 8 Floor
1-1 Minamiwatarida-machi
Kawasaki-ku, Kawasaki-shi
JP - 210-0855
Tel. +81 44 328 76 01
info@beko-technologies.jp

JP**BEKO TECHNOLOGIES Sp. z o.o.**

ul. Pańska 73
PL - 00-834 Warszawa
Tel. +48 22 314 75 40
info.pl@beko-technologies.pl

PL**BEKO TECHNOLOGIES S. de R.L. de C.**

BEKO Technologies, S de R.L. de C.V.
Blvd. Vito Alessio Robles 4602 Bodega 10
Zona Industrial
Saltillo, Coahuila, 25107
Mexico
Tel. +52(844) 218-1979
informacion@beko-technologies.com

MX**BEKO TECHNOLOGIES CORP.**

900 Great Southwest Pkwy SW
US - Atlanta, GA 30336
Tel. +1 404 924-6900
Fax +1 (404) 629-6666
beko@bekousa.com

US

Original manual in German.
bm_8_9_ba_01-3048_en_02_02

