



Operation and Maintenance MANUAL

Stationary Screw Compressor KOMPBERG BSDKF20

CONTENTS

General description	3
Guarantee conditions.....	3
Notifications.....	4
Drawings, diagrams, descriptions and explanations	5
Dimensions	5
Technical parameters	6
Safety regulations	8
Functional diagram	9
Component description	9
Description of the workstation(s)	12
Description of the intended use	13
Warnings concerning ways in which the machinery must not be used	14
Safety and first aid	14
Assembly, installation and connection instructions	16
Operation conditions	16
Before installing the machine.....	16
Installing the machine	16
Instructions relating to installation and assembly for reducing noise or vibration	17
Instructions for the putting into service and usage of the machinery	18
Control panel description	18
BERGcare.....	18
Control panel description (for compressors without a controller).....	19
Logik 26 controller panel (if installed)	19
Frequency inverter panel (if installed).....	21
Commissioning	21
Starting the machine	22
Stopping the machine	22
Emergency shut-down	22
Machine monitoring.....	23
Re-commissioning the machine.....	23
Information about the residual risks	24
Operation notice.....	24
Dangerous materials.....	25
Instructions on the protective measures	26
Low load of the compressor.....	26

Operation in hard climatic conditions	26
Essential characteristics of tools	27
The conditions in which the machinery meets the requirement of stability.....	28
Long term storage preparation.....	28
Instructions with a view to ensuring that transport, handling and storage operations can be made safely.....	29
Machine transport	29
Decommissioning.....	29
Operating method to be followed in the event of accident or breakdown.....	30
Troubleshooting	30
Emergency shut-down	31
Re-starting after an emergency shut-down.....	31
Description of the adjustment and maintenance operations	32
Maintenance schedule	32
Special maintenance intervals	32
Compressor oil.....	33
Oil filter.....	34
Oil separator cartridge	34
Air filter.....	35
Oil cooler.....	35
Safety valve	35
Belt tension check (belt driven compressor)	35
Electric system.....	36
Pressure vessel (if installed)	36
Instructions designed to enable adjustment and maintenance.....	37
Notice for maintenance	37
Maintenance	37
Before maintenance.....	37
Minimal pressure valve	38
Before removing of covers	38
Maintenance on a running machine	38
Maintenance completion	38
Specifications of the spare parts.....	39
Airborne noise emissions	40
Non-ionising radiation	41

GENERAL DESCRIPTION

Contents of this Operation and maintenance handbook are property of BERG. This handbook is altered and updated regularly for each production series and it may not be copied without written permission.

The producer does not assume responsibility for errors occurring from this translation.

This Handbook contains all information necessary for routine operation and maintenance of the machine. More detailed information and procedures for larger repairs are not included in this Handbook but they can be provided by authorized service partners of BERG.

Minor inconsistencies between the Handbook and the actual machine may appear due to improvements of the machine. Ask your dealer if you have any questions or problems.

The machine design complies with relevant EU regulations. This CE Declaration of conformity is losing its validity in case of any not-approved modification of individual machine parts and components.

All parts, accessories, piping, hoses and connections through which the compressed air flows should be

- of guaranteed quality and approved by the manufacturer for intended use,
- approved for the nominal pressure level at least equal to machine maximum operation pressure,
- usable in contact with compressor oil and coolant,
- delivered together with the Handbook for installation and safe operation of the machine.

You will be provided with all details concerning suitability of individual parts use by selling and servicing centers of BERG.

The use of other than original spare parts, fluids and lubricants given in BERG Spare Parts Catalogue could lead to the situation, for which BERG cannot bear any responsibility. In such a case BERG does not take any responsibility for potential damage.

Read the Handbook carefully before operating the machine to fully understand its operation and maintenance requirements.

Guarantee the Operation and maintenance handbook is always at disposal directly by the machine.

Guarantee the maintenance personnel are always professionally trained and acquainted with instructions for operation and maintenance.

Make sure the operating personnel is acquainted with all safety signs and instructions for machine operation before putting it into operation or under maintenance.

Make sure all protective covers are installed and shut before putting the machine into operation.

A weekly visual check must be performed on all fasteners/fixing screws securing mechanical parts. All components which are loose, damaged or out of order must be repaired without delay.

GUARANTEE CONDITIONS

The manufacturer or its authorized service center provides all guarantee and after-guarantee service.

If necessary, please contact the manufacturer or its authorized service center where you will be provided with all necessary information and recommendations.

Guarantee does not cover

- damage caused by incompetent operation and maintenance carried out in contrast with instructions in the Operation and Maintenance Handbook,
- damage caused by incompetent transport, manipulation and storage,
- damage caused by the machine operation in extremely aggressive surroundings,
- consumable materials (filter and separator inserts, V-belts, etc.),
- air end damage caused by corrosion or oil degradation influenced by omission of required inspections.

Guarantee is void

- if filter inserts, separator inserts and other materials have not been replaced in intervals prescribed in the Handbook,
- if the machine has been used for other purposes than those defined in the Handbook,
- if damage has been caused by improper location of the machine in relation to cooling air supply and drain,
- if other than prescribed oils have been used,
- if other than original spare parts have been used,
- if seals have been damaged,
- if the Service Booklet of the machine has not been presented to service engineers during a guarantee inspection or if prescribed operations have not been logged to the Handbook,
- if the machine breakdown has not been caused by a defect due to workmanship,
- if there has been an intervention carried out on the machine construction,
- if the machine has been repaired by other subjects than the manufacturer or its authorised service center,
- if the machine has been handed over another owner without a technical inspection carried out by the manufacturer or its authorised service center,
- if prescribed guarantee inspections have not been carried out on time and have not been logged to this Service Booklet with a coupon sent to the manufacturer,
- if a claim has not been lodged in writing at the latest on the 10th day following the day a defect occurred,
- if damage has been caused by a third person because of insufficient safety precautions,
- if the machine has not been put into operation, operating personnel have not been trained by the manufacturer's authorized service center and this has not been logged to the Service Booklet.

NOTIFICATIONS



Attention

Texts labelled as **Warning** specify precautions, which

- must be followed unconditionally to minimize the risk of injury or death,
- must be followed to avoid damage or defect of the machine or damage to the environment.

Note

Texts labelled as **Note** bring important additional information.

DRAWINGS, DIAGRAMS, DESCRIPTIONS AND EXPLANATIONS

DIMENSIONS

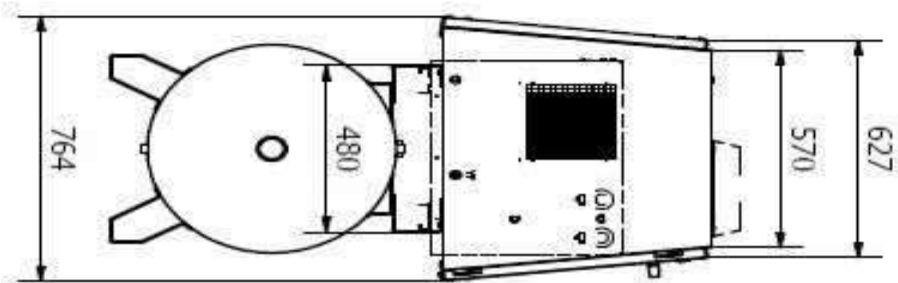
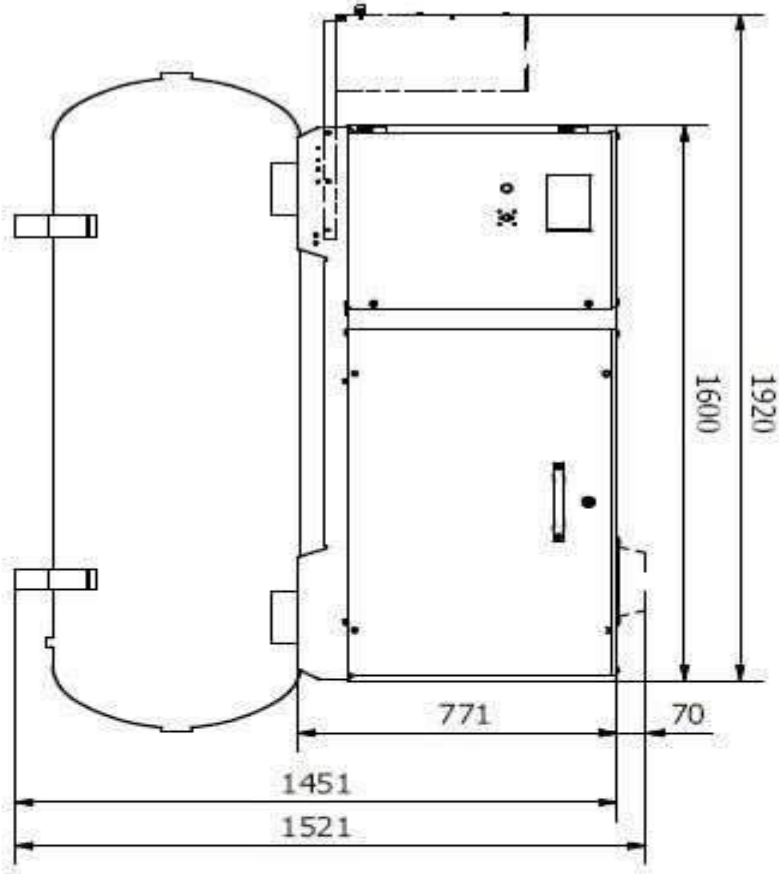

TECHNICAL PARAMETERS

TECHNICAL PARAMETERS

Compressor		KOMPBERG BSDKF20
Air end		BERG B100
Nominal overpressure	[bar]	10,0
Nominal capacity	[m ³ · min ⁻¹]	3,3
Max. air end RPM	[min ⁻¹]	5115
Min. air end RPM	[min ⁻¹]	3234
Maximal power	[kW]	20,0
Safety valve setting	[bar]	13,0
Max. oil system overpressure	[bar]	10,0
Ambient temperature	[°C]	+3 ÷ +40
Max. outlet temperature	[°C]	60
Cooling system		oil injection
Compressor oil filling volume		4,0
Max. oil system temperature		110
Cooling air capacity	[m ³ · h ⁻¹]	

Control system		KOMPBERG BSDKF20
Type/Model		BERG
Control voltage		24 VAC

Drive		KOMPBERG BSDKF20
Nominal power	[kW]	18.5
Nominal RPM	[min ⁻¹]	2940/5115
Nominal voltage		400 V / 50 Hz











**Attention**

Due to machine design it is not possible to use the machine at locations where danger of explosion exists. If the machine is to be operated in such places, all local rules, standards and regulations must be fulfilled by adding of suitable supplementary devices, such as gas detectors, combustion products removal, safety valves, etc. to eliminate all risks.

Note

The machine should be operated in environments with temperature $+3 \div +40$ °C and relative humidity max. 90 %. The machine output decreases as altitude increases.

SAFETY REGULATIONS

 <p>Do not start! Read operation and maintenance manual before start!</p>	 <p>Attention! Hot surface!</p>
 <p>Attention! Read operation and maintenance manual before starting service work!</p>	 <p>Attention! Do not stand on cocks and other parts of the pressure system!</p>
 <p>Attention! Do not operate the compressor while door or covers are open!</p>	 <p>Attention! Do not open the output cock before air hoses are connected!</p>
 <p>Attention! Pressure!</p>	 <p>Compressor oil filling</p> <p>VDL 46</p>
 <p>Attention! Automatic operation!</p>	
 <p>Lifting point</p>	 <p>Anchoring point</p>

FUNCTIONAL DIAGRAM

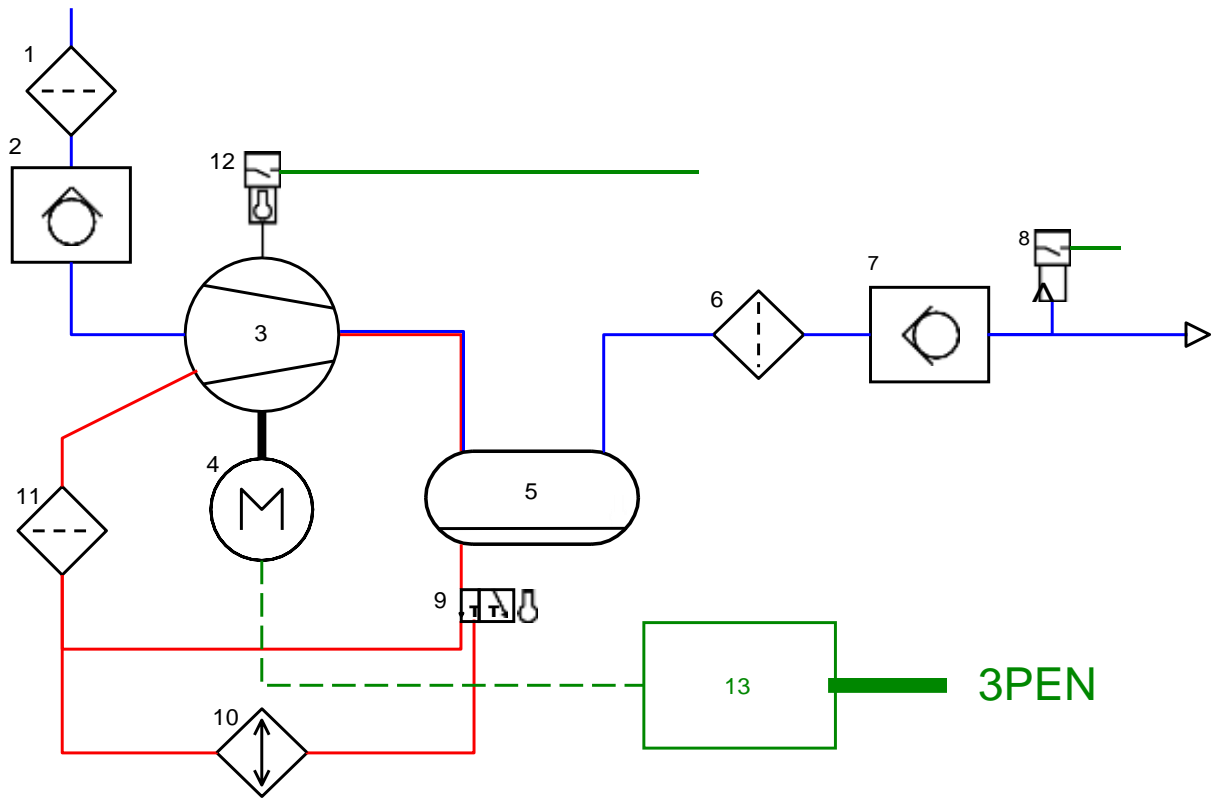

Explanatory notes			
1	Air filter	8	Pressure sensor
2	Suction valve	9	thermostat
3	air end	10	oil cooler
4	engine	11	oil filter
5	separator tank	12	Temperature sensor
6	Separator cartridge	13	Switchboard
7	nozzle / min. pres. valve		
	oil		air

COMPONENT DESCRIPTION

Screw compressor scheme can be found in chapter Functional diagram.

Air and oil circuit

- *Air end* consists of two intermeshing screw rotors laid in roller bearings. The sucked air is compressed among cog gaps. Lubrication and cooling of the air end is provided by oil injection. The air end is propelled by an electric motor.
- *Suction valve* provides opening or closing of the air end suction according to the compressed air consumption. The suction valve also serves as the back-pressure valve.
- *Separator tank* also serves as an air and oil reservoir. In this tank, the oil is being separated from the compressed air. The compressor oil filling plug, oil draining pipe, safety valve and compressor oil circuit piping are placed on the separator tank body.

- *Oil separator cartridge* is mounted on the pressure distribution device. The separator cartridge retains the oil mist present in the compressed air. Retained oil is sucked back to the air end.
- *Minimum pressure valve* is mounted on the compressed air outlet of the separator tank. It opens the compressed air outlet after the overpressure approx. 4.5 bar is reached. This overpressure is sufficient for air end lubrication. The minimum pressure valve also serves as the back-pressure valve and prevents the compressed air from reverse flow.
- *Thermostat* Thermostat ensures the optimal oil operation temperature and thus its desired viscosity. When the oil temperature is low, the cooler by-pass is opened and the oil flows directly back through the oil filter to the air end. When the desired temperature is reached, the by-pass closes and the oil flows through the cooler and the oil filter back to the air end. The proper operation temperature prevents water condensation inside the inner oil circuit, provides proper lubrication and long lifetime of the air end. The condensate inside the inner compressor circuit may cause component corrosion and malfunction of the machine.



Attention

The thermostat settings should be provided by authorized service only!

- *Oil cooler* conducts away the heat produced during the air compression from the compressor oil. The cooler is protected by the cover which also guides the cooling air flow.
- *Air filter* is mounted on the air end suction. The filter consists of plastic body and interchangeable paper insert. The sucked air is purified through the air filter before it continues to the air end. The paper filter insert separates particles larger than 0,01 μ m.
- *Compact oil filter* is mounted on the air distribution cube. The filter is placed before air end oil inlet. The oil filter provides full flow cleaning of the compressor oil.
- *Additional cooling* (if installed) optionally the machine can be equipped with an additional fan which helps the compressor work under more difficult conditions.

Electrical connection

The machine is connected to the three phase current system 3/N/PE AC 400/230 V, 50 Hz. The supply cable is connected directly to the compressor switchboard. The machine is driven by an asynchronous squirrel cage motor with Y- Δ or frequency inverter start-up. The electric motor is in its basic model equipped with roller bearings filled with a permanent lubricant.

Note

Inspection, maintenance and revision of electric motors is provided according to the requirements and recommendations of the motor manufacturer and in compliance with maintenance intervals described in this Handbook.

Automatic run in the set pressure range is provided by several types of optional devices:

- *Pressure switch* - controls the compressor in START/STOP cycle in given pressure range. Temperature switch and motor temperature protection device protect the compressor from failure.
- *Control unit* - the compressor equipped with the control unit (and/or the frequency inverter) is capable to display current setting and status of the machine. You can see the working pressure, oil temperature etc. The machine protection is assured by the control unit.

Maximum working overpressure is stated on the compressor plate. Unload pressure set in the controller/pressure switch cannot exceed this value!



Attention

Operation overpressure is set by the manufacturer. Adjusting is not allowed without permission of the authorized service center!

Electric equipment is separated in the switchboard compartment. These components are accessible after the cover opening..

The control panel is placed on the front side of the cover. The main switch and status indicators (on/off, error, etc.) are placed on the control panel.



Attention

Electric equipment is powered even when the **main power switch** is off. It is necessary to switch off the external main switch or to disconnect the machine from the power supply before maintenance.



Attention

When connecting the machine to power supply, it is necessary to check the direction of the motor and fan. The correct direction is labelled by the arrow on the cooler cover. In case of opposite direction, change the phase order in the supply cable, otherwise there is a risk of the compressor damage!

The machine is equipped with the safety system which shuts down the machine immediately when monitored values (compressor oil temperature, motor overload etc.) exceed their limits. The overpressure protection is further secured by the safety valve on the oil separator tank and pressure vessel.

Pressure vessel

Standard version of the compressor is supplied with the pressure vessel of volumes from 250 to 900 l. Optionally it is possible to deliver the machine with another volume of the vessel or without the pressure vessel.

The pressure vessel serves as pressured air storage. The vessel is equipped with an outlet valve, safety valve or optionally a control valve to reduce the air pressure to constant value necessary for the air tools. The valve in the lower part of the vessel releases the condensate. In the upper part of the vessel there are fixation points for the compressor and/or the dryer.

Compressors equipped with the dryer have the outlet connected to the pressure vessel which means the dryer is placed behind the pressure vessel and the air outlet is behind the dryer.



Attention

The user of the compressor is responsible that the pressure vessel, incl. the safety valve must be checked and tested regularly according to the legislative.

Compressed air dryer

The machine can be equipped with a built-in air dryer. The dryer reduces the relative humidity of the compressed air and therefore prevents water condensation in the compressed air distribution system.



Attention

Compressed air must not flow through the air dryer which is switched off because it can cause damage of the dryer!



Attention

Condensate drained from the dryer should be retained in a suitable container and then disposed according to applicable regulations!

Cover (if installed)

A cover protects the machine against adverse effects of the environment and reduces noise caused by operation of the machine. The cover has openable or withdrawable panels which enable access to all compressor parts. Sound insulation is pasted on the inner surface of the cover. Suction and exhaust of the cooling air are covered to reduce the compressor noise.



Attention

Never remove thermal and/or sound insulation including sealing profiles on covers!

DESCRIPTION OF THE WORKSTATION(S)

Does not apply.

DESCRIPTION OF THE INTENDED USE

Compressed air can be dangerous when used improperly! Before any operation, maintenance or machine repair - the pressure system should be completely empty (free from over-pressure). Besides this, the machine must be secured against accidental starting.

Make sure the machine will be operated on nominal pressure only and the compressor operating personnel are acquainted with this instruction. Pressure level of compressed air equipment connected to the machine must be at least the same as the machine nominal pressure level.



Attention

Under no circumstances compressed air is allowed to be used for direct human respiration!



Attention

Compressed air can cause serious injury or death. Relieve overpressure before removing filler plugs/caps, fittings or covers.



Attention

Residual air pressure in the air system can cause serious injury or death. Always carefully vent the air supply line to tools or cocks before any maintenance.

Output air contains a small amount of compressor oil. For this reason it is necessary to verify the compatibility of all used equipment connected to the compressed air source.

If compressed air flows into the closed space, it is necessary to provide cooling of the air.

All personnel must always wear proper protective clothes when working with compressed air.

All pressure loaded parts including the pressure hoses must be tested regularly. No signs of damage should be observed and all parts should be used in conformance with instructions for their use and/or for their intended purpose.

Avoid contact with compressed air.

The safety valve on the oil separator should be tested regularly according to given instructions.

When the machine is stopped, compressed air can flow back into the compressor system from connected devices or piping, unless the service valve is closed. Install a back pressure valve at the machine outlet cocks to avoid reverse flow in the event of an unexpected shut-down when the outlet cocks are open. Disconnected air hoses whip and can cause serious injury or death. Always attach a safety flow restrictor to each hose according to safety rules.

The supposed ways to use the machine are presented below. If the machine should be used in an unusual way or in an unusual surroundings *please contact the manufacturer*.

This machine has been designed and supplied for use under following conditions only:

- compressing the usual air which does not contain any additional gases, vapours or additives,
- the machine will be operated at temperatures shown in chapter Technical parameters,
- the machine will be operated in conformance with this Operation and maintenance handbook,
- the machine will be connected to the power supply which complies all the standards of the distribution power network valid in given country.

WARNINGS CONCERNING WAYS IN WHICH THE MACHINERY MUST NOT BE USED

Due to machine design it is not possible to use the machine at locations where danger of explosion exists. If the machine is to be operated in such places, all local rules, standards and regulations must be fulfilled by adding of suitable supplementary devices, such as gas detectors, combustion products removal, safety valves, etc. to eliminate all risks.



Attention

Air discharged from this machine may contain carbon monoxide or other contaminants which will cause serious injury or death. Do not breathe this air.



Attention

The machine is powered even when the main switch is turned off. Never inspect or service the machine without previous disconnection of the power supply to prevent accidental starting of the machine.

The machine produces loud noise with its doors open or a service valve vented. Extended exposure to loud noise can cause hearing loss. Always wear hearing protectors when the doors are open or the service valve is vented.

Never operate the machine with guards, covers or screens removed. Keep hands, hair, clothing, tools, etc. away from moving parts.

Rotating fan blades can cause serious injury. Do not operate the machine without a fan guard installed.

Avoid contact with hot surfaces (an engine exhaust manifold and pipping, an air receiver and air discharge pipping, etc.).

Do not use petroleum products (solvents or fuels) under high pressure as this can penetrate the skin and result in serious illness. Wear eye protection while cleaning the machine with compressed air to prevent eye injury.

The machine is not allowed to be used :

- as a direct supply of pressurized air for respiration purposes,
- for indirect human consumption without suitable air filtration and purity check,
- out of temperature range specified in the general information section of this handbook,
- in surroundings containing explosive gases or vapours,
- with accessories, components, lubricants and coolants not recommended by BERG,
- for operation with not functional safety or control elements of without these elements.

SAFETY AND FIRST AID

Electrical equipment fire safety

When oil leakage or defect occur, or during maintenance, there is a risk of fire due to careless manipulation with open fire, welding etc.

Fire procedure:

- *electrical equipment is not powered*: use foam fire extinguisher (according to current regulations), dry sand or soil can be used in emergency.
- *electrical equipment is powered*: powdered fire extinguisher (according to current regulations) must be used when extinguishing the fire of the electrical equipment or in its vicinity. Safety distance at least 2 m from the equipment must be maintained. The continuous water stream is not allowed to be used min. 30 m from the device.

Electrical accident first aid

Organizations dealing with higher risk of electrical accidents are obligated to provide safety measures and first aid procedures, such as employee trainings and first aid kits placement. First aid brief instructions should be placed on a visible spot.

First aid procedure:

- Switch off the main power switch, disconnect the device from the power socket, push away the power cable or the

victim (with a dry log, dry rope, dry clothes) to get the victim out of the reach of electric current. If possible, use only one hand. Do not touch the victim or parts of his/her wet clothes by bare hand.

- In case of emergency provide artificial respiration and heart massage.
- Call the doctor.
- Inform the immediate superior as soon as possible.

ASSEMBLY, INSTALLATION AND CONNECTION INSTRUCTIONS

OPERATION CONDITIONS

The standard version of the machine is designed for common interior usage. Maximum temperature range is stated in chapter Technical parameters, the air rel. humidity should be max. 90 % and absolute humidity should not exceed 15 g/m³. Contact the authorized service center in case of intended use in different conditions.

Additional approval is necessary namely for environment, where

- temperature exceeds max. operation temperature range, or the fast temperature changes occur,
- dustiness or humidity is high or the other influences are present.

BEFORE INSTALLING THE MACHINE

Follow these instructions during the machine installation:

- Use only appropriate lifting and transport means. Special attention to protect outlet cocks during transport is recommended.
- Remove all blinding covers etc. All connected equipment must correspond to the maximum operation pressure of the compressor.
- Ensure the proper electrical connection in compliance with the current regulations.
- Sufficient cooling air supply should be provided. The air must not contain flammable or explosive substances.
- The suction opening should be secured against sucking of the loose objects.
- No external forces should act on the outlet cock.
- Control elements, service spots and pressure connections (incl. the pressure vessel connections) should be accessible.
- Install the first aid kits and fire extinguishers near the machine, so that they are available in case of emergency.

INSTALLING THE MACHINE

1. The machine Make sure that the machine is positioned on a horizontal stable ground. The compressor installation does not require special foundations or binding spots. Keep in mind that compressor should be accessible during the maintenance and do not place it right next to the walls or other possible obstacles.
2. Connect the outlet piping to the pressure air system. The piping connection should prevent the transmission of vibrations or other improper forces to the machine.
3. Connect the condensate drain(s) to the condensate drain system. The condensate drain(s) should be at the highest point, so the condensate can flow just by gravity.
4. Connect the compressor to the power supply. If needed, connect the remote control or superior control system according to the el. schematics. The power supply must be fused and equipped with an emergency shut-down switch.

If more than one compressor are connected to the pneumatic equipment at the same time, every machine should be equipped with a non-return flap valve to avoid back air streaming through the output cocks into the machine.

INSTRUCTIONS RELATING TO INSTALLATION AND ASSEMBLY FOR REDUCING NOISE OR VIBRATION

The compressor body is equipped with noise absorption panels used for noise control. The machine cannot be operated without these noise absorption panels.

The machine was designed to reduce all risks caused by vibrations to the lowest level.

INSTRUCTIONS FOR THE PUTTING INTO SERVICE AND USAGE OF THE MACHINERY

CONTROL PANEL DESCRIPTION

BERGCARE

BERGCare system protects the compressor from damage when the replacement intervals of the oil separator, oil filters etc. have been exceeded. Consequently it protects systems of compressed air treatment and distribution from damage or contamination caused by a large amount of oil (dryers, filters etc.) BERGCare system enables operation of the compressor only equipped by an original chip, which is delivered with the set of spare parts for particular service interval according to the type of the machine and environment. BERGCare system monitors operation time of the compressor and it activates the compressor according to the situation. The chip can be a part of the diagnostic system which provides complex diagnostics of the machine incl. service reports for BERG service office (according to the configuration).



BERGCare running is indicated by a red indicator on the front panel (compressors without the control system) or directly on the control system panel of the compressor. During activation of the system (switching the machine on) the indicator blinks once to three times (according to the compressor type).

- *indicator off* - the compressor works in normal mode
- *indicator blinking (twice per second)* - the compressor is coming near its service interval (less than 200 hours)
- *indicator on permanently* - service interval has been exceeded, the compressor reduces its operation to safe level
- *indicator blinking fast* - the chip cannot be read, the machine operation is reduced



Attention

Without a chip installed (with valid running hours) operation of the compressor can be blocked.

The reader incl. the chip connector is placed in the compressor switchboard. The connector is accessible from the side of the control panel (compressors without an acoustic cover) or inside the switchboard. Its status indicator is placed on the control panel.



Attention

Protect the reader as well as the chip from humidity, pollution, electric discharge or strong magnetic field.



Attention

Never manipulate with the chip when the switchboard is under voltage!

CONTROL PANEL DESCRIPTION (FOR COMPRESSORS WITHOUT A CONTROLLER)

The compressor is operated by the pressure switch. The main voltage is switched on by the main switch (3). Then the BERGcare system initializes. The compressor can be switched on by pressing the START button - green operation indicator switches on. If the indicator is on, the engine starts and stops automatically according to the set outlet pressure.

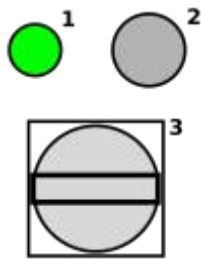

description	function
1	operation indicator
2	START button
3	main switch

LOGIK 26 CONTROLLER PANEL (IF INSTALLED)





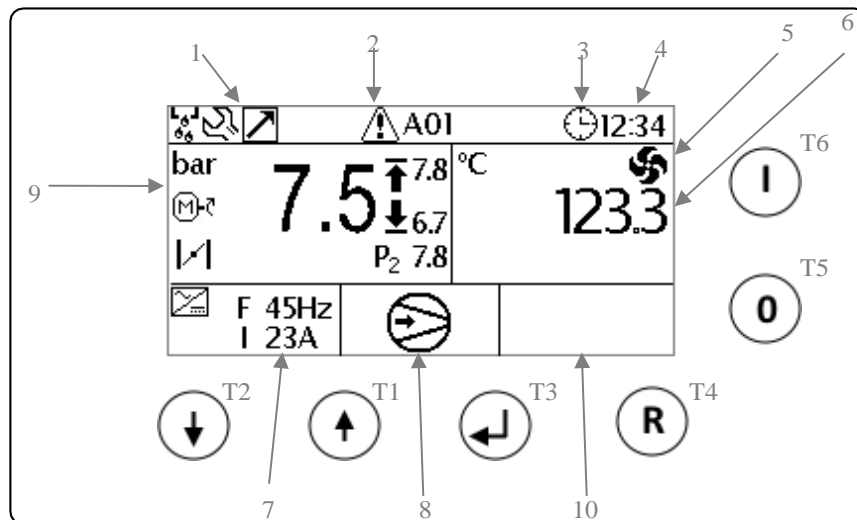

















All machine functions are operated by the controller placed on the front panel. The compressor is switched on by pressing the START button (T6) and switched off by pressing the STOP button (T5).

The ENTER button (T3) opens the user's menu or submenu and displayed variables can be changed by using the arrows (T1 a T2). The RESET button (T4) erases the alarm entries (if the alarms are not active) and returns the controller to the starting screen.



id	description	id	description
1	status icons	6	oil temperature
2	warning/maint. messages	7	inverter info
3	time schedule	8	timer
4	time	9	compressor status
5	fan running	10	dryer status

Compressor status can be seen in fields 9 and 6, where you can see current working pressure, its upper and lower level and internal compressor pressure (if the sensor is installed), together with compressor oil temperature and a status icons. Icons description:

Main visualization: icons located on the upper row		
I01		Condensate drain activated
I02		Multiunit operation activated
I03		Master/slave operation activated
I04		Maintenance timer over
I05		Alarm
I06		Weekly start/stop timer activated
Main visualization: icons related to compressor status located lower row (center)		
I07		Compressor OFF
I08		Waiting for safety timer
I09		Pressure set, compressor running unload or stand-by
I10		Remote start/stop input open
I11		Compressor running
I12		Stop by timer: the display visualizes day and time of the next start
I13		Internal pressure P2 too high
Main visualization: left square = pressure – right square: temperature		
I14		Fan ON
I15		PID and output 4/20mA enabled
I16		Stop pressure
I17		Start pressure
I18		Motor running
I19		Compressor running load (load solenoid valve activated)
Menu setting: date, time, contrast, units of measurement		
I20		Unit of measurement activated
I21		Contrast
I22		Language
I23		Date and time

FREQUENCY INVERTER PANEL (IF INSTALLED)

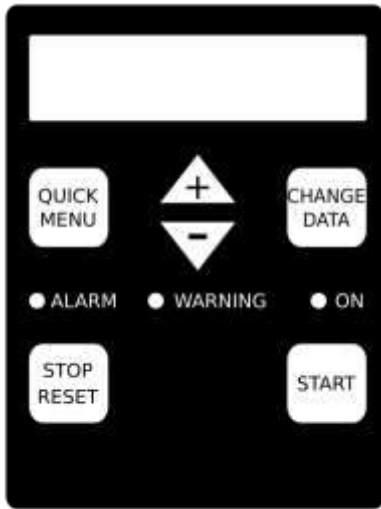

	Indicators
ALARM	alarm indicator
WARNING	warning indicator
ON	running indicator
	Control buttons
+/-	display switch button
STOP/RESET	stop/reset the inverter
START	start the inverter

Inverter display (Vario compressors) is placed on the front panel of the switchboard. It shows the drive status (immediate power, RPN, etc.) and - with no control unit - even working pressure of the compressor.

The green indicator (**ON**) must still be active, while the inverter is ready to start/running. If the display shows alarm or warning (**ALARM** or **WARNING** indicators), this notification can be erased by pressing the **STOP/RESET** button after the failure has been repaired. If the compressor is not running, the display is blinking. When in operation, the display is still.

! Attention

- Never reset the alarm unless its cause has been removed. The alarms and warnings are recorded and repeated starting the machine despite the warning sign can lead to permanent damage of the compressor which may not be covered by the guarantee.

! Attention

- Unauthorised change of the controller/inverter parameters can lead to permanent damage of the compressor and must always be consulted with authorised service center. The manufacturer is not responsible for any losses caused by unauthorised manipulation with the control units of the compressor.

COMMISSIONING

Make sure that the operating personnel read and understand the rules and follow the instructions given in this handbook before the machine operation or maintenance. Check all other risks, which may occur when operating the machine.

Note

Before putting the machine into operation after a more than one month lay-off period follow the instructions in Re-commissioning the machine and/or contact the authorized service center.

1. Check the oil in the separator vessel. Check possible leakage in the oil circuit.
2. Check all outlet plugs and a funnel are properly tightened.
3. Check the electrical equipment including the electrical connection and its short-circuit protection.

! Attention

- Before putting the machine into operation check the motor rotation direction and thus the air end direction. If the motor turns in the opposite direction, shut down the machine immediately and change the phase order of the connection cable. There is a risk of machine damage!



Attention

If the compressor is equipped with independent cooling system, check a fan rotation direction before putting the machine into operation. The air must flow towards the cooler. If the fan turns in the opposite direction, shut down the machine immediately and change the phase order of the fan cable. There is a risk of machine damage!



Attention

The machine controlled by the pressure switch may be operated only when it is connected to the pressured air system equipped with the air receiver. The volume of the air receiver must be sufficient enough to keep the compressor re-start count below 10 times per hour (in 8 hours average). The re-start period should always be longer than 4 minutes. This must be checked after putting the machine into operation, or after significant air consumption change. When in doubt, contact the manufacturer!

STARTING THE MACHINE

1. Close all covers and check, that the outlet valves are open.
2. Turn the main switch to "I" position. This will switch on the main power supply. The controller should be switched on. Both LEDs (green and red) are off.
3. Turn the machine on by pressing the green START button.
4. The main motor will start immediately and the green LED will blink.
5. The fan motor will start after few seconds. The suction regulator will open, the green LED will be on.
6. When the maximal pressure is reached, the suction regulator will close and the compressor will idle waiting for pressure to drop below minimal pressure. The green LED will blink.

Note

If the system pressure is above the minimal pressure, the compressor will not start and wait in standby mode.

Note

The machine works in automatic mode and is switch on and off according to the pressure level.

STOPPING THE MACHINE

1. If remote controlled, it is recommended to switch to local control.
2. The machine can be switched off by pressing the red STOP button.
3. After the STOP button is pressed, the suction regulator closes and the compressor idles. This time is used for the compressor to cool down, green LED is blinking.
4. After the compressor stops, turn the main switch to "0" position.



Attention

Even when the main switch is switched off, the compressor remains under voltage. Disconnect the power supply and close the outlet cocks before starting the maintenance work.

EMERGENCY SHUT-DOWN

In case of emergency, the compressor can be stopped by pressing the emergency button or turning off the main switch. In this case, the motor power supply is cut off immediately. See Emergency shut-down for more details.

**Attention**

Do not use the emergency button for regular shut down.

MACHINE MONITORING

1. Check periodically the oil and air circuit staunchness.
2. Check the air operation overpressure. Its value must not exceed the set pressure limit.
3. Check if the machine closes the intake valve and stops after the maximum pressure is reached.

In extreme conditions make sure the instructions stated in chapter Instructions on the protective measures are followed.

RE-COMMISSIONING THE MACHINE

Before putting the machine into operation after a more than one month lay-off period perform the regular maintenance and take the following precautions. Contact the manufacturer if necessary.

recommended preliminary instructions	1 month	2 months	6 months	1 year
electrical connection check	X	X	X	X
power clamps tightening check	X	X	X	X
pressure circuit leakage check	X	X	X	X
suction filter check	X	X	X	X
oil level check	X	X	X	X
test run, oper. pressure check	X	X	X	X
suction filter disassembly, pour 0.2 l of oil through the suction valve to the air end		X	X	X
run the machine and check, if it stops after reaching maximum pressure		X	X	X
oil and oil filter change (not mandatory for synthetic oil)			X	X
motor connection cables and clamps check				X

When the machine is out of operation for more than 12 months, please contact the authorized service center.

**Attention**

Keep the machine clean. The air end must be clear of impurities, otherwise there is a risk of air end damage!

Stated instructions serve to basic orientation when putting the machine back to operation. Some precautions are desirable to be performed in advance or repeated according to the compressor state and working conditions. (It is recommended to contact the authorized service center.)

INFORMATION ABOUT THE RESIDUAL RISKS

OPERATION NOTICE

- Maintain sufficient ventilation and air supply for the compressor cooling system.
- Do not transport or otherwise manipulate the machine when this is running.
- Use only intact piping and hoses which meet the compressor requirements.
- The machine must not be operated out of the nominal parameters.
- All covers must be in place while the machine is running. The only exception is regular maintenance. Use ear protection during the maintenance.
- Safety devices, protective covers, heat and noise isolation must not be removed.
- Pay extra attention and wear protective glasses while using the compressed air for cleaning purposes.
- While cleaning hoses using the compressed air secure their ends against whipping.
- Regular maintenance is required when the machine is in operation.



Attention

Before starting the machine, check all the safety devices incl. covers. All defects should be removed before starting the machine.

Wear protective clothes, helmet, ears and eyes protection, safety shoes, gloves and in special cases even a mask while working with compressed air.

Do not approach the fan, do not touch rotating parts. All rotating parts can cause serious injury.

Do not wear loose clothes, a tie or a scarf, various accessories, such as loose jewellery while operating the machine. These can be caught or sucked to the rotating parts of the machine and may cause serious injuries.



Attention

The running machine is under pressure! There is a risk of injury when operated by unqualified personnel.

Nominal pressure of all installed or attached equipment must be the same or higher than nominal pressure of the machine. All used materials must be resistive to compressor oil.



Attention

Under no circumstances open the filling plug of the separator tank while the machine is running on under pressure. Hot air and oil may splash and cause serious injury.



Attention

Some compressor parts, esp. oil piping, air end and separator tank may reach temperature over 100 °C during the operation.

Note

Free air delivery should be approx. 20 % higher than the actual compressed air consumption for optimal operation of the machine. Required performance margin depends on compressed air consumption diagram, volume of the pressure and the whole system, etc.

The manufacturer cannot be held responsible for any damage or injuries caused by omitting safety and maintenance instructions in this Handbook or other legal requirements, performing unauthorized interventions to the machine incl. those not stated in this Handbook.

DANGEROUS MATERIALS

! **Attention**
• The condensate is created during the machine operation. It should be collected and disposed in compliance with valid legislation.

Following materials which, if used improperly, can be harmful to health have been used to build and operate the machine:

- compressor oil,
- preservation grease,
- anti corrosive coatings.

! **Attention**
Prevent contact of these materials with skin and do not inhale the vapours!

After contact with eyes, immediately flush them with running water for at least 5 minutes. After contact with skin, wash it immediately. In cases of ingestion, seek medical help immediately. When inhaled excessive amount of the substance, seek medical help immediately. Never give fluids to a victim in convulsions, try to induce vomiting.

These safety instructions are taken from manufacturers of these substance.

INSTRUCTIONS ON THE PROTECTIVE MEASURES

LOW LOAD OF THE COMPRESSOR

! **Attention**

When operating the compressor on low load (below 50 %, depending on the ambient conditions), the operating temperature of the oil does not reach the optimal value 70 – 85 °C. The air water condensate is accumulated in the separator tank.

To keep the optimal operation life of the oil, oil separator cartridge and to avoid air end corrosion, it is necessary to follow these instructions:

If the compressor is used occasionally or on low load, make sure it reaches the optimal working temperature. It is recommended to keep the compressor running at least once per week for min. 1 hour at working pressure.

1. When optimal working temperature is reached, the condensate is separated and disposed from the compressor.
2. In this case, it may be necessary to relieve the compressed air to the atmosphere. Use silencer to eliminate the noise.
3. Consult the authorized service center for suitable maintenance intervals.

If this is not possible, relieve the condensate from the oil separator tank at least once per week. Refill the oil, when needed. This should be performed before putting the machine into operation after a shut down longer than 12 hours.

Note

If the water condensation is extreme and thus emulsion in the whole oil filling is created, contact the manufacturer and consult the possible change of the oil type.

OPERATION IN HARD CLIMATIC CONDITIONS

Operation during the winter season

1. The compressor should be stored in tempered room with minimal storage temperature +5 °C.
2. If the temperature is low, consult the use of the proper oil type with the authorized service center.

Operation in an extremely dusty environment

1. Pay special attention to regular cleaning of heat exchange surfaces of the coolers and electric motor.
2. Check the air intake filter regularly.
3. Reduce exchange intervals of the oil filter and air filters.
4. Reduce exchange intervals of oil fillings according to the manufacturer's recommendation.

ESSENTIAL CHARACTERISTICS OF TOOLS

All parts, accessories, piping, hoses and connections through which the compressed air flows should be:

- of guaranteed quality and approved by the manufacturer,
- approved for the nominal pressure level at least equal to machine maximum operation pressure,
- usable in contact with compressor oil and coolants,
- delivered together with the Handbook for installation and safe operation.

You will be provided with details regarding suitability of individual parts by BERG sell and service centers.

THE CONDITIONS IN WHICH THE MACHINERY MEETS THE REQUIREMENT OF STABILITY

Principles set forth in the following text are very important for safety of operation personnel working on disassembly, adjustment and maintenance of the undercarriage braking system.

LONG TERM STORAGE PREPARATION

If the machine is to be kept unused in a storage for a longer time period, place the machine to a dry dust free place. Before re-commissioning the machine, follow instructions according to the chapter Re-commissioning the machine.

INSTRUCTIONS WITH A VIEW TO ENSURING THAT TRANSPORT, HANDLING AND STORAGE OPERATIONS CAN BE MADE SAFELY

MACHINE TRANSPORT

When loading or transporting the machine, make sure only prescribed lifting and towing devices with minimal allowed force and speed suitable for the machine mass and transport speed are used. Make sure only proper lifting and fastening points are used when loading or transporting the machine.

DECOMMISSIONING

Parts of the machine classified as dangerous waste should be disposed according to waste legislation:

- engine oil and compressor oil filling,
- oil, air and fuel filters,
- other oil contaminated parts.

Parts classified as special waste which should be recycled or given to certified authority for disposal:

- cables, wires and other electrical equipment,
- rubber and plastic parts,
- heat isolating materials made of mineral fibres.

OPERATING METHOD TO BE FOLLOWED IN THE EVENT OF ACCIDENT OR BREAKDOWN

TROUBLESHOOTING

Problem	Cause	Solution
The compressor produces low amount of air.	Suction filter soiled.	Replace the filter insert.
	Regulation system soiling.	Clean the regulation system, contact the manufacturer's service partner.
	System leakage.	Contact the authorized service.
The compressor cannot reach the appropriate air pressure.	An intake valve does not work properly.	Check the intake valve.
	Oil filling loss.	Check the oil level.
The machine runs up heavily.	Compressor under pressure.	Check the intake valve.
	Low ambient temperature.	Heat up the machine, consider change of oil type.
	Dense oil.	Change oil, check the oil type.
The machine turns off before the demanded pressure is reached.	Defective pressure sensor/switch.	Check the pressure sensor/switch connection. Contact the authorized service.
	Motor overload.	Check the running overpressure.
	Defective overload relay.	Contact the authorized service.
The machine turns off due to high oil temperature.	Insufficient oil volume.	Refill the compressor oil.
	Oil filter soiled.	Change the oil filter.
	Oil cooler soiled.	Clean the oil cooler.
	High ambient temperature. Defective temperature sensor.	Consider changing the machine location. Contact the authorized service.
Safety valve leaking.	Separator cartridge soiled.	Change the separator cartridge.
	Defective safety valve.	Contact the authorized service.
	An intake valve does not work properly.	Contact the authorized service.
Oil in compressed air.	Clogged oil drawing off.	Clean the oil drawing off plug.
	Defective separator insert.	Change the separator cartridge.

This table serves for a customer's basic orientation when a problem with the machine or its parts appears. Problems leading to the machine shut down are signalled on a control board display. When a problem appears, please contact the manufacturer's service partner immediately.

EMERGENCY SHUT-DOWN

In case of emergency, the compressor can be stopped by pressing the emergency button or the main switch. In this case, the motor power supply is cut off immediately.

RE-STARTING AFTER AN EMERGENCY SHUT-DOWN

After an emergency shut-down, find and solve the problem before an attempted re-start.

If the machine has been switched off from safety reasons, make sure the machine can be operated safely before an attempted re-start.

Before re-starting the machine, follow the instructions in Starting the machine. The

machine should shut-down under these conditions:

- high internal pressure,
- high outlet pressure,
- high air end discharge temperature,
- motor overload.

DESCRIPTION OF THE ADJUSTMENT AND MAINTENANCE OPERATIONS

MAINTENANCE SCHEDULE

Maintenance intervals	first check *	daily	monthly	monthly	1 year	1 year	1 year	2 years
running hours	100	8	100	500	1000	2000	3000	6000
Compressor oil	I	I				R ¹⁾		
Compressor oil filter	I					R		
Oil/air leakage	I	I						
Overpressure, temperature	I	I						
Scavenger orifice	I	I			C			
Air filter			I			R		
Safety valve				I				TR
Cooler				IC				
Power cables clamps	I			IA				
Air end belt								
Suction valve (service kit)	I				I			
motor bearings (lubrication)						I		
Separator cartridge						R		
Min. pressure valve (service kit)						IR		
Separator tank	I						P	
Emergency shut down	T							T
Pressure transducer								T

* First maintenance check is recommended to increase the reliability in the running-in state.

Explanatory notes	
I	inspect
R	replace
A	add/adjust/tighten
T	test
C	clean
P	inspect (protocol)

¹⁾ Compressor oil refill intervals depend on used oil type and working environment. Consult the manufacturer's authorised service center.

SPECIAL MAINTENANCE INTERVALS

BERG compressor warranty validity is modified according to the working environment (CSN EN 33 2000-3).

maintenance	service interval		
	A	B	C
environment			
Air filter	2000	1000	500
Compressor oil filter	2000	1000	500
Compressor oil ¹⁾	2000	1000	500
Separator cartridge	2000	1000	500
motor bearings (lubrication)	2000	1000	500

¹⁾ Compressor oil changing interval depends on the compressor oil type. Please consult with authorized service.

Temperature

label	characteristic				interval
	min. temp.	max. temp.	max. rel. hum.	max. abs. hum.	
	[° C]	[° C]	[%]	[g/m ³]	
AB4	+5 ²⁾	+40 ²⁾	85	25	A

²⁾ Ambient temperature range depends on compressor oil type. Please consult with authorized service.

Solid particles, dust

label	class	characteristic	interval
AE1	negligible	dust concentration is very low	A
AE4	low dustiness	soft layers of dust, dustiness between 10 and 35 mg/m ² per day	B
AE5	moderate dustiness	layers of dust, dustiness between 35 and 350 mg/m ² per day	C
AE6	high dustiness	severe layers of dust, dustiness between 350 and 1000 mg/m ² per day	special requirements

Corrosive or aggressive materials

label	class	characteristic	interval
AF1	negligible	corrosive or aggressive materials in very low concentration	A
AF4	permanent	permanent presence of corrosive or aggressive materials	special requirements

COMPRESSOR OIL

Compressor oil specification

Compressors are originally filled with BERG OIL 4 compressor oil, which can be used year-round.

! **Attention**
 Potential use of other oil type should be consulted with the manufacturer!

! **Attention**
 The manufacturer is not responsible for damage caused by use of improper oil or disrespecting maintenance intervals!

Note

If the machine is operated under hard climatic conditions, the authorized service shall recommend heavy duty oil or ecological friendly oil.

Oil check

Always check the oil level before starting the machine, or after the oil level is stabilized.

Follow these instructions to check the oil level:

1. Shut down the compressor and secure it against the random start.
2. Wait at least 10 minutes to stabilize the oil level.
3. Remove the front cover of the compressor.
4. Read the oil level from the oil level indicator placed on the separator tank.
5. *The oil level should range in the upper half of the oil level indicator.*
6. Put all the covers in place before re-starting the machine.



Attention

Keep in mind, that the surface of the separator tank can be very hot!

Oil change The oil changing intervals can be found in chapter Maintenance schedule. The oil should be changed only by the authorized service center.

Note

If the machine is operated under hard climatic conditions, such as (**permanently increased or decreased ambient temperature, high dustiness, technical gases compression**) or is out of operation for longer time period, it is necessary to shorten the maintenance intervals.



Attention

Never, under no circumstances open the filling or relieving plugs from the oil system, without making sure the machine is stopped, protected against random or automatic start and the system has been completely depressurized (see chapter Stopping the machine).

OIL FILTER

Oil filter maintenance intervals are stated in chapter Maintenance schedule. The oil filter should always be replaced together with the compressor oil change. Oil filter should be replaced by the authorised service center only.



Attention

Before dismantling the oil filter, make sure the machine is stopped and the system was completely depressurized (see chapter Stopping the machine).



Attention

After the oil or oil filter replacement, always check all the plugs and possible leakage in the oil system.

OIL SEPARATOR CARTRIDGE

Oil separator cartridge maintenance intervals can be found in chapter Maintenance schedule. The oil separator cartridge does not require any regular maintenance providing the air and oil filters are maintained properly. It is recommended to replace the oil separator cartridge at the same time with the oil change. The separator cartridge maintenance should be provided by the authorized service only.



Attention

Before dismantling the oil separator cartridge, make sure the machine is stopped and the system was completely depressurized (see chapter Stopping the machine).

AIR FILTER

The air filter should be checked regularly and the cartridge should be replaced according to chapter Maintenance schedule). The air filter cartridge replacement should be provided by authorized service only.

Note

If the machine is operated under hard climatic conditions or is out of operation for longer time period, it is necessary to shorten the maintenance intervals.



Attention

Do not dismantle the filter when the machine is running.

OIL COOLER

The compressor cooling works efficiently only when the cooler is clean. The cooler should be cleaned regularly according to the working environment dustiness. The cooler can be cleaned with compressed air. When this is not satisfactory, use the cleaning bath.

Always check that the inlets as well as outlets of the air are clean and there are no obstacles in the air flow.

It is recommended for the oil cooler to be dismantled by the authorized service center.



Attention

The inside of the machine should never be cleaned with the compressed air.

SAFETY VALVE



Attention

The air from the safety valve is under high pressure. Never bring your hands or face close to the open safety valve.

Use safety glasses.

The safety valve should be checked according to the valid legislation, but at least once a month.

To check the safety valve, close all the outlet valves and gently loose the safety valve lid. The working pressure should be at least 5 bar (0.5 MPa). Even when the lid is loosened minimally, the pressured air should be relieved. Do not forget to tighten the lid after the check!

BELT TENSION CHECK (BELT DRIVEN COMPRESSOR)

Belt tension check should be provided by the authorized service center.

The belt tension is set by the gradual tightening or loosening of the fastening screw at the belt case. The proper tension is stated on the belt case.

ELECTRIC SYSTEM

The electric devices incl. sensors do not require any special maintenance. Check the electric connectors and tighten the clamps according to the maintenance schedule.



Attention

It is necessary to check and tighten all the electric clamps before putting the machine into operation.

Pressure and temperature sensors When in doubt that the sensors are working properly, contact the authorized service center to check the sensor.

Electromagnetic valves Never dismount the control solenoid from the valves, when the valves are live. There is a risk of permanent damage. When checking its function, unplug the connector from the power supply.

Electric motor The electric motor should be checked regularly according to the operation conditions. It is necessary to keep the motor clean. The motor soiling leads to undesirable temperature increase and thus reduction of the motor effective life.

Regular checking and tightening of the motor clamps is necessary. Prescribed torque for brass screws and M6 nuts is 4 Nm (M8 - 8 Nm, M10 - 13 Nm).

If the compressor motor is not equipped with bearing lubrication, the bearings or lubricating grease replacement is performed according to the recommendation of the manufacturer, but at least once per 3 years.

The motor bearing are lubricated with plastic lithium based grease for temperature range -30 °C to 130 °C, drop point min. 170 °C. The maintenance intervals are stated in chapter Maintenance schedule. When changing the grease, the bearings should not be overfilled with the grease. This may lead to temperature increase and damage of the bearings. The Mogul LV2-3, Shell Alvania R2 nebo R3, Esso Beacon 2, Mobilgrease 22, BP Energrease LS3, SKF65, etc. are recommended.



Attention

Electric motor inspection should be performed in intervals and range according to valid legislation.

PRESSURE VESSEL (IF INSTALLED)

Relieve the condensate regularly (according to the ambient conditions) by opening the relieve valve on the pressure vessel. The condensate should be relieved, when the overpressure is max. 0.5 bar. The valve should be opened gradually to prevent the condensate splash. The condensate should be relieved to a proper container and disposed according to the local legislation. Check the safety valve of the pressure vessel at least once per month (see paragraph safety valve).

Note

Operation, maintenance and check of the pressure vessel is regulated by local legislation (CSN 69 0012).

INSTRUCTIONS DESIGNED TO ENABLE ADJUSTMENT AND MAINTENANCE



Attention

Before any maintenance or repairs stop the machine, secure it against the unintended start and release the pressure! Follow all safety instructions including those not mentioned in this Handbook.

Note

Every compressor is supplied with the Service booklet where it is recommended to log all operations performed during maintenance. Guarantee inspections, regular service operations and repairs carried out by BERG service center should be logged in the Service booklet as well.

NOTICE FOR MAINTENANCE

- Only appropriate tools and original spare parts supplied by BERG Service center may be used for repairs.
- During the maintenance shut-down the machine should be secured against unintended starting and disconnected from the compressed air supply.
- Always use appropriate protective equipment. Notably when operating the machine with its cover open (a check-up, adjusting, etc.) use hearing protection.
- It is not allowed to carry out any modifications to the compressor unit and notably to the air end without knowledge of the manufacturer or the service organization.
- When cleaning the parts, detergents must not get into the machine inner circuit. Keep the machine clean and prevent contamination of the inner pressure circuit.
- Protect the electrical parts against excessive humidity.
- After finishing the repairs, operation parameter settings and safety equipment including detectors and sensors must be checked.

Note

The manufacturer does not take responsibility for any damages and injuries caused by ignoring given operation or safety instructions during operation, check-ups, maintenance or repairs including those not mentioned in this Handbook but generally accepted for used machines and other devices..

MAINTENANCE

This section refers to various components which require periodic maintenance and replacement.

The service/maintenance table specifies operation descriptions and intervals when maintenance should be carried out. Oil refills, etc. can be found in chapter Drawings, diagrams, descriptions and explanations of this Handbook.

Compressed air can be dangerous if handled improperly. Before any operation make sure, the machine is not under pressure and can not be started accidentally.

If the automatic depressurization system fails, pressure should be relieved manually by the operating personnel. Appropriate personal protective equipment should be used.

Make sure the operating personnel are adequately trained, qualified and acquainted with the maintenance manuals.

BEFORE MAINTENANCE

Before any maintenance operations, make sure that:

1. Air pressure is fully discharged and the machine is disconnected from the air pressure system. Wait for the automatic depressurization system to relieve all air pressure.

2. Relieve the overpressure from the separator tank and the discharge tubes by opening the outlet cocks. Stay out from the air stream while the overpressure is being discharged.
3. The machine should be secured against accidental starting. Label the machine with a warning sign or use suitable equipment to prevent the machine from starting.
4. All residual electrical power sources (mains and battery) should be isolated.

MINIMAL PRESSURE VALVE

Overpressure may remain between the minimal pressure valve and the outlet cock even after automatic depressurization.

This overpressure should be relieved carefully by:

1. disconnecting of the attached device(s),
2. opening the outlet cocks to the atmosphere (use hearing protection if necessary).

BEFORE REMOVING OF COVERS

Before opening or removing of covers to work inside the machine, make sure that:

- When working inside the machine, be aware of reduced protection level and other risks, including hot surfaces and intermittently moving components.
- The machine should be secured against accidental starting. Label the machine with a warning sign or use suitable equipment to prevent the machine from starting.

MAINTENANCE ON A RUNNING MACHINE

Before any maintenance on a running machine, make sure that:

- The work carried out is limited to only those tasks which require the machine to run.
- The work carried out with safety protection devices disabled or removed is limited to only those tasks which require the machine to be running with safety protection devices disabled or removed.
- Be aware of all possible risks (e. g. pressurized and live components, removed panels, covers or guards, extreme temperatures, air inflow and outflow, intermittently moving components, safety valve outlet, etc.))
- Appropriate personal protective equipment is used.
- Secure loose clothing, jewellery, long hair, etc.
- Visibly display a warning sign "Maintenance work in progress".

MAINTENANCE COMPLETION

For maintenance completion and before operating the machine, make sure that:

- The machine has been tested adequately.
- All safety and protective devices have been reinstalled.
- All panels have been reinstalled, covers and doors have been closed.
- Dangerous materials have been properly stored and disposed.

SPECIFICATIONS OF THE SPARE PARTS

CPN	Description
427900101018	Separator cartridge
627960000930	Compressor oil filter
427700001131	Air filter
427900000105	thermostat
272711600740	Air end belt
N000051	Suction valve (service kit)1
N000052 (N000053)	Suction valve (service kit)2
N202420=8	Min. pressure valve (service kit)

Spare parts specifications can be found in the space parts catalogue.

AIRBORNE NOISE EMISSIONS

Acoustic pressure level A in the operation station is max. 78 dB(A).

NON-IONISING RADIATION

The machine does not emit non-ionizing radiation.

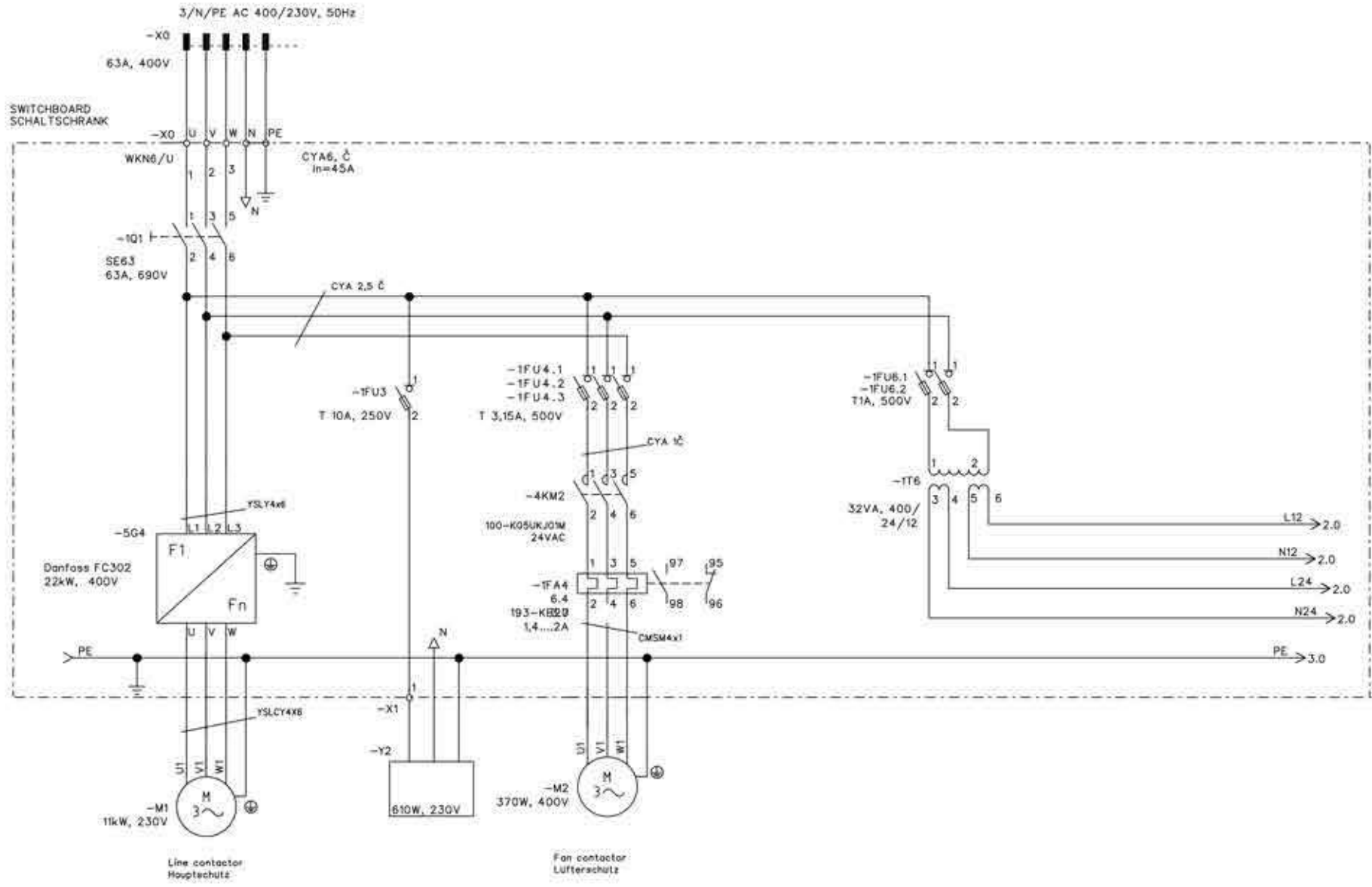

			Datum:	21.2.2011
a				
Revision	Date	Signature		
Revision	Date	Unterschrift		

COMPRESSOR BSDKF 20
KOMPRESSOR BSDKF 20

Typ:
Main circuits
Hauptschaltbild

Number of pages	5
Blattzahl:	
Page:	1
Blatt:	

Drawing No.	At 401 036S
Zeichnung No.	

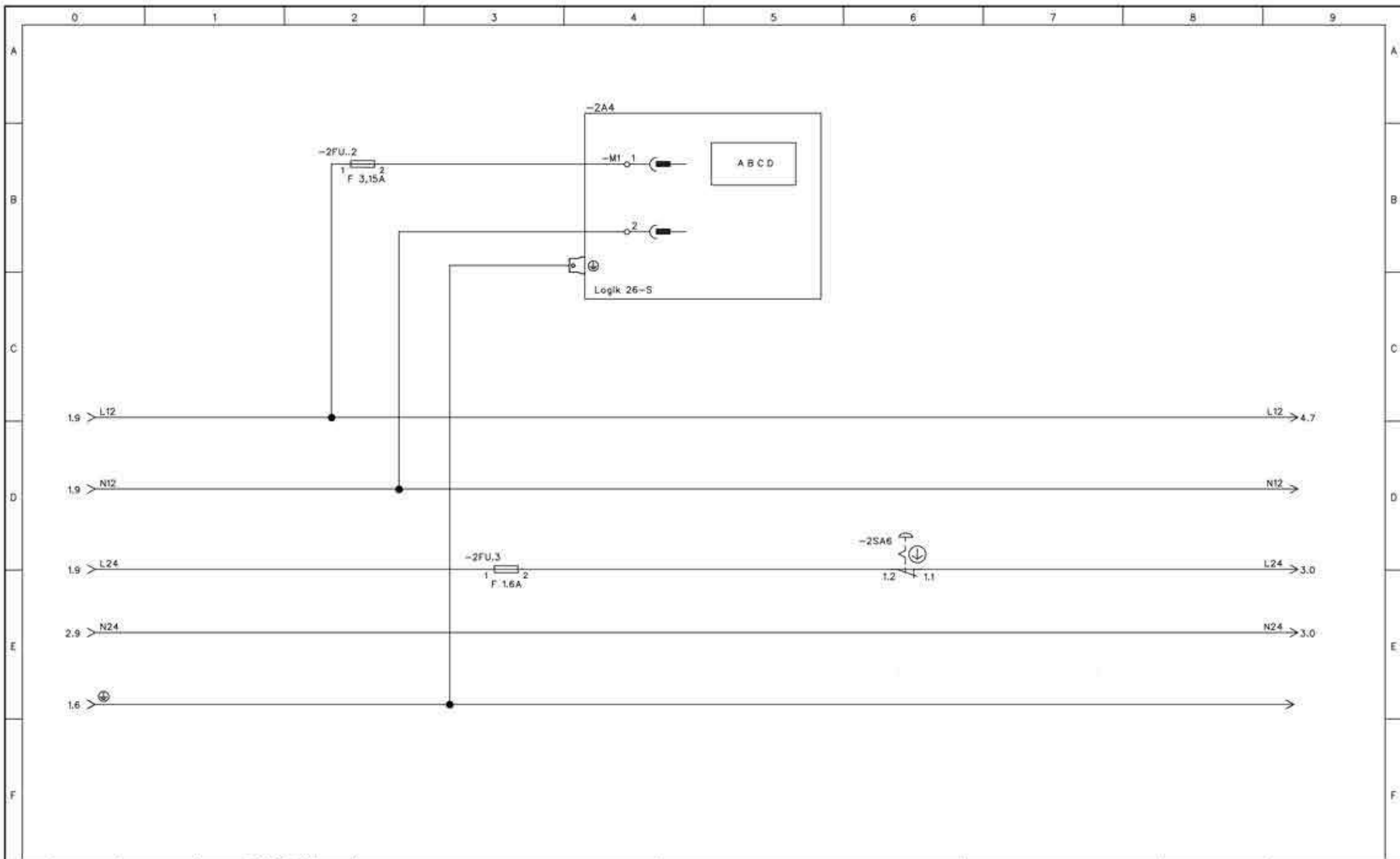

			Datum	21.2.2011			Number of pages:	5	Page:	2
					COMPRESSOR BSDKF 20		Blattzahl:		Blatt:	
					KOMPRESSOR BSDKF 20					
Revision	Date	Signature				Typ:				
Revision	Datum	Unterschrift				Auxiliary circuits				
						Sekundärschaltbild				
							Drawing No.:	At 401 036S		
							Zeichnung No.:			

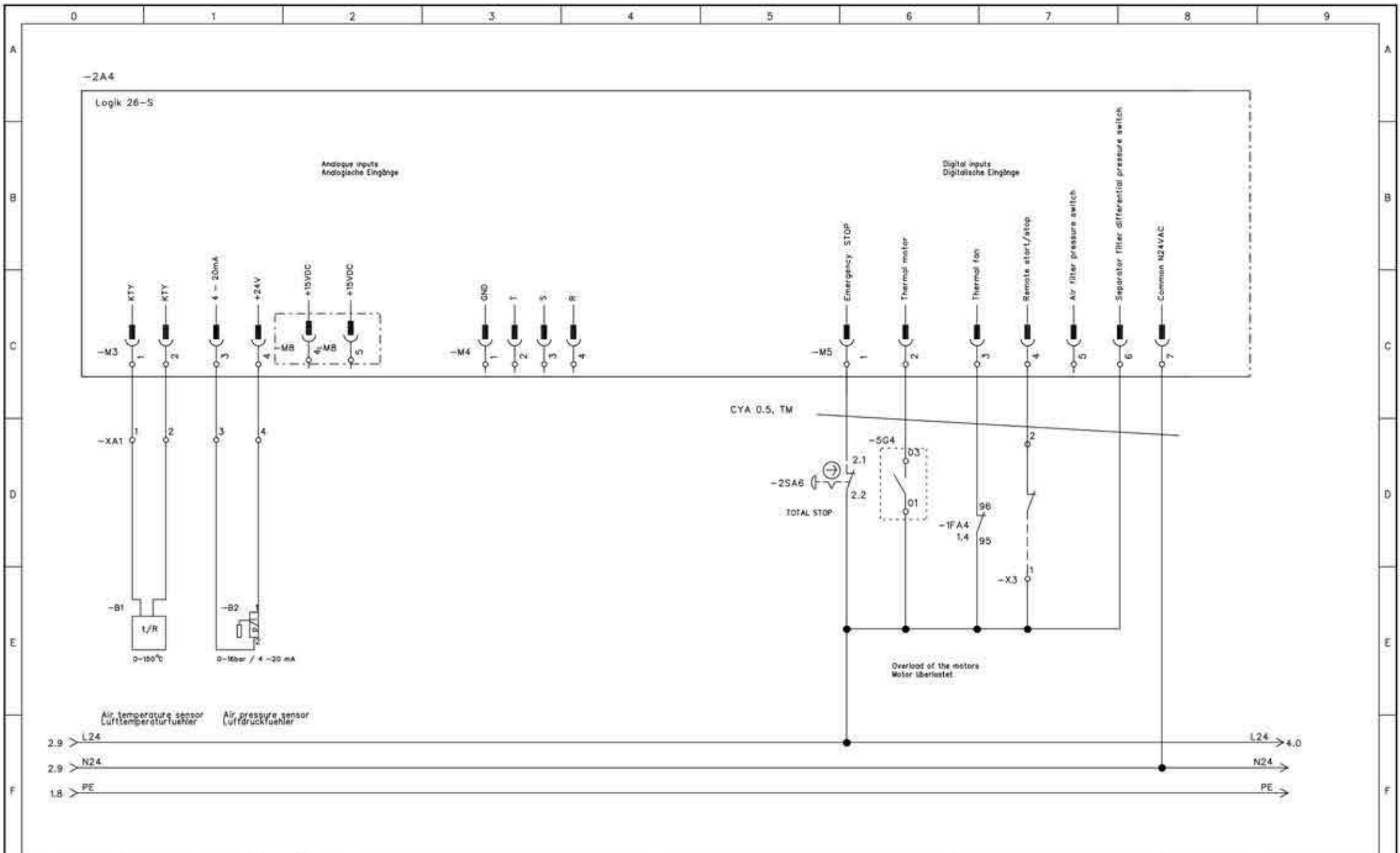

Revision	Date	Signature	Datum
			21.2.2011

COMPRESSOR BSDKF 20
KOMPRESSOR BSDKF 20

Typ:
Analogue and digital inputs
Analogische/digital. eingänge

Number of pages Blattzahl:	5	Page Blatt	3
Drawing No. Zeichnung No.	At 401 036S		

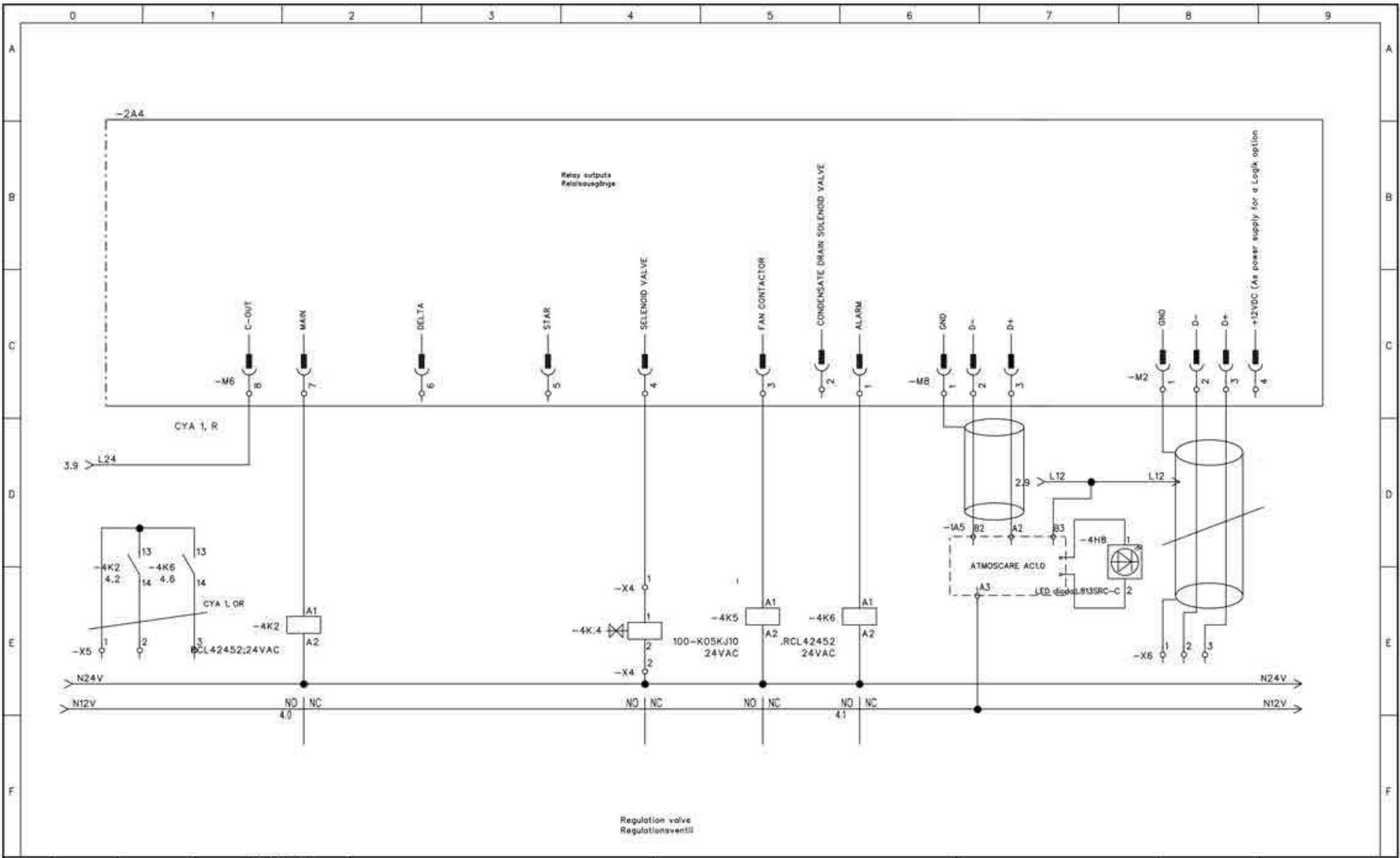

		Datum	21.2.2011
a			
Revision	Date	Signature	
Revision	Date	Unterschrift	

COMPRESSOR BSDKF 20
KOMPRESSOR BSDKF 20

Typ:
 Relay outputs
 Relais Ausgänge

Number of pages: Blattzahl:	5	Page Blatt	4
Drawing No. Zeichnung No.	At 401 036S		

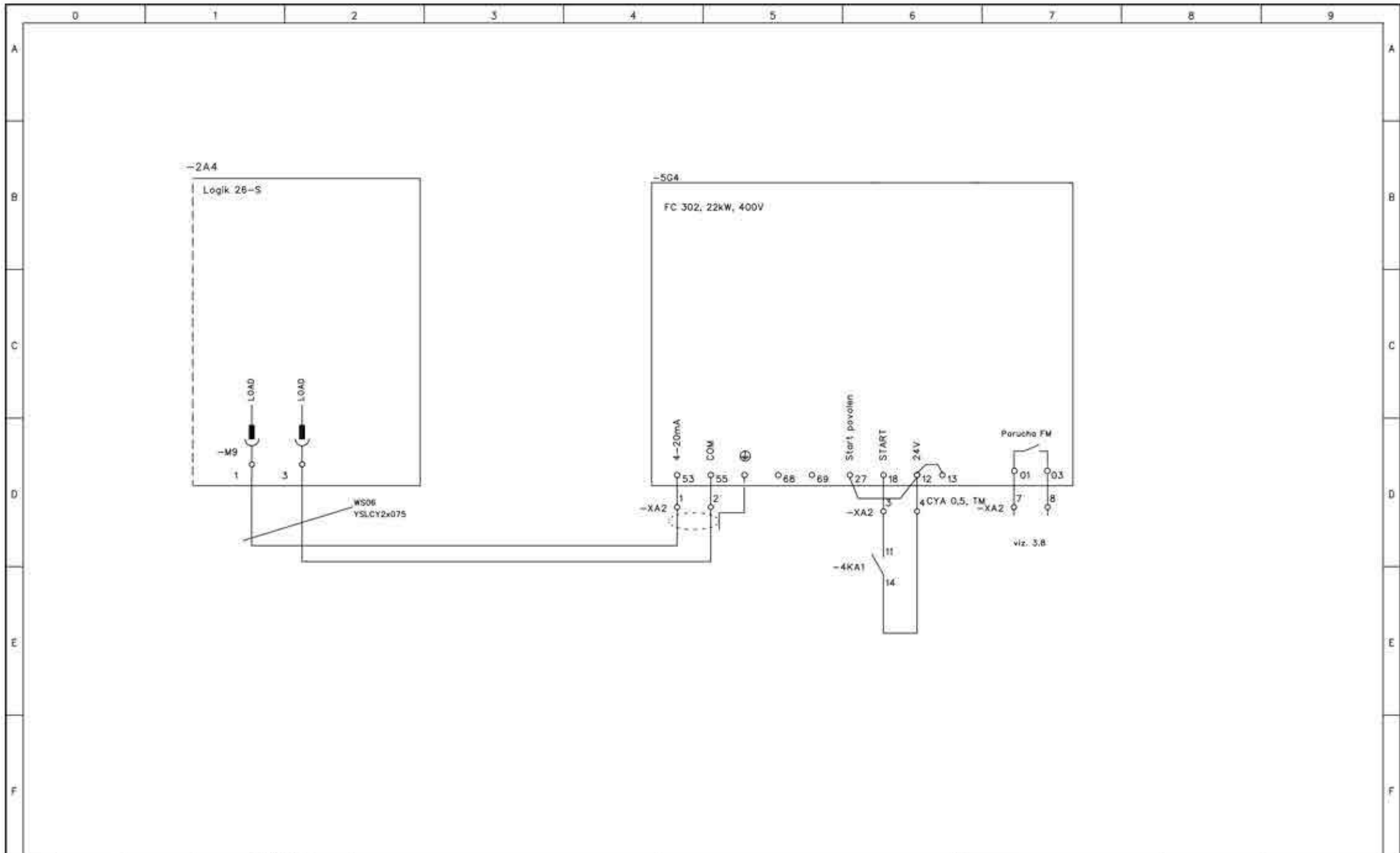

a		Datum	21.2.2011
a			
Revision	Date	Signature	
Revision	Datum	Unterschrift	

COMPRESSOR BSDKF 20
KOMPRESSOR BSDKF 20

Typ:
 Control of convete
 Steuerung des Frequezersetter

Number of pages Blattzahl:	5	Page Blatt	5
Drawing No. Zeichnung No.	At 401 036S		



Commissioning Report/ Warranty Registration for Screw Compressors

Service-partner/ distributor: _____

Customer no: _____ Customer Name: _____

Project/ invoice no: _____

Zip code/ City: _____ Country: _____

Compressor data:

Type: KOMPBERG® _____ kW _____ bar _____ Serial no: _____

Date of commissioning: _____ Year of production: _____

- Integrated with water separator inside
 Integrated in Interconnected intelligent control system
 Integrated with heat exchanger, heat recovery system

Date of installation of compressor: _____ Operating hours: _____

Compressor installation conditions:

Location: Open area (hall, tent..) Enclosed area (compressor room, container...) Ship Lorry/train Barn
 Covered outdoor Not covered outdoor area. Factory/production Biogas plant Below ground Other

Ventilation: Exhaust duct (length: ___m) Brackets/valves Air intake duct Booster fan

Ambient conditions: Clean Dusty Dirty Humid Vapors/chemical exposure

Check operations to be carried out:

BEFORE commissioning

Master switch/Circuit breaker available / installed

Tighten all oil hoses/air hoses/pipes
 Check/tighten all electrical connections

Measure belt tension (N/Hz)
 Electr. HRC fuse as stated in technical specifications: _____

Flexible discharge hose (air) or compensator installed

Mains supply: ___ V (measured)

L1: ___ L2: ___ L3: ___

BEFORE / DURING test run

Check oil level

Check direction of rotation
 Maximum pressure bar ___ checked
 Restarting pressure bar ___ checked

Check for oil/air leakages

___ °C Oil temperature after 30 minutes load cycle

___ °C Ambient temperature

Power input in load cycle

L1: _____ A L2: _____ A L3: _____ A

AFTER test run

Check for air leakages

Check for oil leakages
 Run-on time setting ___ sec
 Belt tension after test run if available

Power input in idle cycle:

L1: _____ A L2: _____ A L3: _____ A

Extended warranty: 2 years 3 years 4 years 5 years

Filtration: Pre-filter Fine filter Active carbon filter. Cyclone separator

Special application: Nitrogen Oxygen Medical use Other: _____

Dryer: Type: DRYBERG® _____ kW _____ bar _____ Serial no: _____

Performance test Dew point monitoring int./ext. Dew point after 30min test run: _____

Information for customers:

- All handbooks and keys for doors handed to customer
 All the necessary functions of the compressor/ control explained to customer
 Customer informed of the weekly necessary visual checks (leakages, oil level, pre-filter...)

Signature of customer (authorized person/engineer): _____

Signature of distributor/service partner: _____

Date: _____

Your signature confirms that the above mentioned BERG Kompressoren GmbH equipment has been properly installed and that your compressor has been handed over and functions correctly!